

Skyline Agility Club (Club #44)

Saturday, November 19, 2022

Jumpers

Distance: 106 yds SCT: 48 secs **Level 1 Regular/Veteran** 20 inch Judge: JoLee Yeddo
 Place Armband CPE ID Call Name Handler Time TFlts Bar Off Oth Maj Total

1Q 20007 32263-01 **Dash** J. Sample 18.71 0 0 0 0 0 0
 20009 24743-04 **Ellie** C. Jersey NT 0 0 0 0 0

Distance: 106 yds SCT: 43 secs **Level 2 Regular/Veteran** 16 inch Judge: JoLee Yeddo
 Place Armband CPE ID Call Name Handler Time TFlts Bar Off Oth Maj Total

1Q 16019 33472-01 **KiKi Party** K. McNeil 34.50 0 0 1 0 0 5

Distance: 106 yds SCT: 43 secs **Level 2 Regular/Veteran** 20 inch Judge: JoLee Yeddo
 Place Armband CPE ID Call Name Handler Time TFlts Bar Off Oth Maj Total

2 20010 33736-02 **Angel** S. Khera 64.81 21 0 1 0 1 41
1Q 20020 33736-01 **Apollo** S. Khera 35.86 0 0 0 0 0 0
 20019 31772-01 **Wilbur** T. Messenger NT 0 0 0 0 0

Distance: 106 yds SCT: 58 secs **Level 1 Enthusiast** (12) 8 inch Judge: JoLee Yeddo
 Place Armband CPE ID Call Name Handler Time TFlts Bar Off Oth Maj Total

1Q 12001 T 20873-03 **Oliver** M. Carlin 40.82 0 1 0 0 0 5

Distance: 106 yds SCT: 53 secs **Level 1 Enthusiast** (20) 16 inch Judge: JoLee Yeddo
 Place Armband CPE ID Call Name Handler Time TFlts Bar Off Oth Maj Total

20018 T 22118-03 **Gator** K. Kalfas NT 0 0 0 0 0

Distance: 106 yds SCT: 48 secs **Level 2 Enthusiast** (20) 16 inch Judge: JoLee Yeddo
 Place Armband CPE ID Call Name Handler Time TFlts Bar Off Oth Maj Total

20002 T 31306-01 **Tillie** A. Selzner Absent

Distance: 106 yds SCT: 48 secs **Level 2 Enthusiast** (24) 20 inch Judge: JoLee Yeddo
 Place Armband CPE ID Call Name Handler Time TFlts Bar Off Oth Maj Total

1Q 24001 T 33373-01 **Loki** L. Gambill 38.26 0 0 0 0 0 0

Skyline Agility Club (Club #44)

Saturday, November 19, 2022

Jumpers

Distance: 131 yds SCT: 43 secs **Level 3 Regular/Veteran** 16 inch Judge: JoLee Yeddo
Place Armband CPE ID Call Name Handler Time TFlts Bar Off Oth Maj Total

1Q 16012 18274-04 **Aurora** D. Coglietta 31.03 0 0 1 0 0 5

Distance: 131 yds SCT: 43 secs **Level 3 Regular/Veteran** 20 inch Judge: JoLee Yeddo
Place Armband CPE ID Call Name Handler Time TFlts Bar Off Oth Maj Total

20008 32620-01 **Wallace** B. Tomeck NT 0 0 0 0 0

Distance: 131 yds SCT: 43 secs **Level 5 Regular/Veteran** 12 inch Judge: JoLee Yeddo
Place Armband CPE ID Call Name Handler Time TFlts Bar Off Oth Maj Total

1 12010 18198-03 **Jennie** S. Budd 58.68 15 0 0 0 0 15

Distance: 131 yds SCT: 38 secs **Level 5 Regular/Veteran** 16 inch Judge: JoLee Yeddo
Place Armband CPE ID Call Name Handler Time TFlts Bar Off Oth Maj Total

2 16011 18274-03 **Cooper** D. Coglietta 24.03 0 1 1 0 0 10
1Q 16001 06411-04 **Jedi** J. Hamilton 32.24 0 0 0 0 0 0

Distance: 131 yds SCT: 38 secs **Level 5 Regular/Veteran** 20 inch Judge: JoLee Yeddo
Place Armband CPE ID Call Name Handler Time TFlts Bar Off Oth Maj Total

2Q 20011 24743-03 **Gibbs** C. Jersey 39.97 1 0 0 0 0 1
1Q 20005 25468-04 **Breeze** J. Franke 28.24 0 0 0 0 0 0
3 20004 V 10804-02 **Bosworth** S. Cappiello 46.27 8 0 1 0 0 13

Distance: 131 yds SCT: 43 secs **Level C Regular/Veteran** 8 inch Judge: JoLee Yeddo
Place Armband CPE ID Call Name Handler Time TFlts Bar Off Oth Maj Total

2 8002 26964-01 **Lilly** K. Wasko 38.19 0 0 1 0 0 5
1Q 8003 08144-05 **Mia** M. Buchel 36.70 0 0 0 0 0 0
3 8004 20344-02 **Junior** N. Kowal 42.25 0 1 0 0 0 5

Distance: 131 yds SCT: 43 secs **Level C Regular/Veteran** 12 inch Judge: JoLee Yeddo
Place Armband CPE ID Call Name Handler Time TFlts Bar Off Oth Maj Total

1 12007 19315-03 **Myles** K. Krajcovic 31.93 0 0 2 0 0 10

Distance: 131 yds SCT: 38 secs **Level C Regular/Veteran** 16 inch Judge: JoLee Yeddo

Place	Armband	CPE ID	Call Name	Handler	Time	TFlts	Bar	Off	Oth	Maj	Total
3	16002	04813-06	Dori Blue	B. Hartman	28.00	0	0	1	0	0	5
2Q	16007	30105-01	Jem	M. Samuels	22.05	0	0	0	0	0	0
1Q	16016	04813-05	Ici Blue	B. Hartman	20.49	0	0	0	0	0	0

Distance: 131 yds SCT: 38 secs **Level C Regular/Veteran** 20 inch Judge: JoLee Yeddo

Place	Armband	CPE ID	Call Name	Handler	Time	TFlts	Bar	Off	Oth	Maj	Total
2Q	20021	10804-03	Fergie	S. Cappiello	31.01	0	0	0	0	0	0
4	20014	12713-03	Andy	L. Garfinkel	41.97	3	0	1	0	0	8
1Q	20001	04813-07	Aggi Jo	B. Hartman	27.53	0	0	0	0	0	0
3Q	20003 V	25468-03	Spark	J. Franke	32.66	0	0	0	0	0	0

Distance: 131 yds SCT: 48 secs **Level 5 Enthusiast** (12) 8 inch Judge: JoLee Yeddo

Place	Armband	CPE ID	Call Name	Handler	Time	TFlts	Bar	Off	Oth	Maj	Total
1Q	12002 T	20873-02	Sophie	M. Carlin	45.65	0	0	0	0	0	0

Distance: 131 yds SCT: 48 secs **Level 5 Enthusiast** (16) 12 inch Judge: JoLee Yeddo

Place	Armband	CPE ID	Call Name	Handler	Time	TFlts	Bar	Off	Oth	Maj	Total
1	16004 T	22581-04	Little Man	L. Bollenbach	34.46	0	0	1	0	0	5

Distance: 131 yds SCT: 43 secs **Level 5 Enthusiast** (20) 16 inch Judge: JoLee Yeddo

Place	Armband	CPE ID	Call Name	Handler	Time	TFlts	Bar	Off	Oth	Maj	Total
1	20015 T	27736-01	Jethro	R. Thompson	30.43	0	0	2	0	0	10

Distance: 131 yds SCT: 48 secs **Level 5 Specialist** (16) 8 inch Judge: JoLee Yeddo

Place	Armband	CPE ID	Call Name	Handler	Time	TFlts	Bar	Off	Oth	Maj	Total
	16010 S	23210-01	Maisie	R. Tucker	Absent						

Skyline Agility Club (Club #44)

Saturday, November 19, 2022

Wildcard

Distance: 78 yds SCT: 40 secs **Level 1 Regular/Veteran** 20 inch Judge: JoLee Yeddo
 Place Armband CPE ID Call Name Handler Time TF WCs Bar Off Oth Maj Tot

1Q	20007	32263-01	Dash	J. Sample	19.57	0	112	0	1	0	0	5
	20009	24743-04	Ellie	C. Jersey	NT	0		0	0	0	0	

Distance: 78 yds SCT: 35 secs **Level 2 Regular/Veteran** 20 inch Judge: JoLee Yeddo
 Place Armband CPE ID Call Name Handler Time TF WCs Bar Off Oth Maj Tot

2Q	20010	33736-02	Angel	S. Khera	39.69	4	112	0	0	0	0	4
3	20008	32620-01	Wallace	B. Tomeck	31.86	0	112	2	0	0	0	10
4	20019	31772-01	Wilbur	T. Messenger	54.32	19	112	0	0	0	0	19
1Q	20020	33736-01	Apollo	S. Khera	39.41	4	112	0	0	0	0	4

Distance: 78 yds SCT: 50 secs **Level 1 Enthusiast** (12) 8 inch Judge: JoLee Yeddo
 Place Armband CPE ID Call Name Handler Time TF WCs Bar Off Oth Maj Tot

1	12001 T	20873-03	Oliver	M. Carlin	51.65	1	12	0	1	0	1	21
----------	---------	----------	---------------	-----------	-------	---	----	---	---	---	---	----

Distance: 78 yds SCT: 45 secs **Level 1 Enthusiast** (20) 16 inch Judge: JoLee Yeddo
 Place Armband CPE ID Call Name Handler Time TF WCs Bar Off Oth Maj Tot

	20018 T	22118-03	Gator	K. Kalfas	NT	0		0	0	0	0	
--	---------	----------	--------------	-----------	----	---	--	---	---	---	---	--

Distance: 78 yds SCT: 40 secs **Level 2 Enthusiast** (20) 16 inch Judge: JoLee Yeddo
 Place Armband CPE ID Call Name Handler Time TF WCs Bar Off Oth Maj Tot

	20002 T	31306-01	Tillie	A. Selzner	Absent							
--	---------	----------	---------------	------------	--------	--	--	--	--	--	--	--

Distance: 78 yds SCT: 40 secs **Level 2 Enthusiast** (24) 20 inch Judge: JoLee Yeddo
 Place Armband CPE ID Call Name Handler Time TF WCs Bar Off Oth Maj Tot

1Q	24001 T	33373-01	Loki	L. Gambill	38.74	0	112	0	0	0	0	0
-----------	---------	----------	-------------	------------	-------	---	-----	---	---	---	---	---

Skyline Agility Club (Club #44)

Saturday, November 19, 2022

Wildcard

Distance: 91 yds SCT: 39 secs Level 3 Regular/Veteran						16 inch Judge: JoLee Yeddo						
Place	Armband	CPE ID	Call Name	Handler	Time	TF	WCs	Bar	Off	Oth	Maj	Tot
1Q	16001	06411-04	Jedi	J. Hamilton	41.31	2	122	0	0	0	0	2
	16012	18274-04	Aurora	D. Coglietta	NT	0		0	0	0	0	

Distance: 91 yds SCT: 39 secs Level 5 Regular/Veteran						12 inch Judge: JoLee Yeddo						
Place	Armband	CPE ID	Call Name	Handler	Time	TF	WCs	Bar	Off	Oth	Maj	Tot
1	12010	18198-03	Jennie	S. Budd	48.82	9	122	0	1	0	0	14

Distance: 91 yds SCT: 34 secs Level 5 Regular/Veteran						20 inch Judge: JoLee Yeddo						
Place	Armband	CPE ID	Call Name	Handler	Time	TF	WCs	Bar	Off	Oth	Maj	Tot
2	20011	24743-03	Gibbs	C. Jersey	32.35	0	122	0	2	0	2	40
1Q	20005	25468-04	Breeze	J. Franke	35.54	1	122	0	0	0	0	1
	20016 V	14850-06	Innes	K. Mazarak	Absent							

Distance: 91 yds SCT: 39 secs Level C Regular/Veteran						8 inch Judge: JoLee Yeddo						
Place	Armband	CPE ID	Call Name	Handler	Time	TF	WCs	Bar	Off	Oth	Maj	Tot
2Q	8002	26964-01	Lilly	K. Wasko	33.31	0	122	0	0	0	0	0
1Q	8003	08144-05	Mia	M. Buchel	32.17	0	122	0	0	0	0	0
3Q	8004	20344-02	Junior	N. Kowal	36.69	0	122	0	0	0	0	0

Distance: 91 yds SCT: 39 secs Level C Regular/Veteran						12 inch Judge: JoLee Yeddo						
Place	Armband	CPE ID	Call Name	Handler	Time	TF	WCs	Bar	Off	Oth	Maj	Tot
1	12007	19315-03	Myles	K. Krajcovic	29.88	0	122	1	0	0	0	5

Distance: 91 yds SCT: 34 secs Level C Regular/Veteran						16 inch Judge: JoLee Yeddo						
Place	Armband	CPE ID	Call Name	Handler	Time	TF	WCs	Bar	Off	Oth	Maj	Tot
1Q	16002	04813-06	Dori Blue	B. Hartman	16.00	0	122	0	0	0	0	0
3Q	16011	18274-03	Cooper	D. Coglietta	27.36	0	122	0	0	0	0	0
4	16007	30105-01	Jem	M. Samuels	17.70	0	12	0	0	0	1	15
2Q	16016	04813-05	Ici Blue	B. Hartman	17.75	0	122	0	0	0	0	0

Distance: 91 yds SCT: 34 secs Level C Regular/Veteran						20 inch Judge: JoLee Yeddo						
Place	Armband	CPE ID	Call Name	Handler	Time	TF	WCs	Bar	Off	Oth	Maj	Tot
2Q	20021	10804-03	Fergie	S. Cappiello	24.42	0	122	0	0	0	0	0

	20014	12713-03	Andy	L. Garfinkel	35.99	1	122	0	0	0	0	1
1Q	20001	04813-07	Aggi Jo	B. Hartman	23.59	0	122	0	0	0	0	0
4Q	20004 V	10804-02	Bosworth	S. Cappiello	33.08	0	122	0	0	0	0	0
3Q	20003 V	25468-03	Spark	J. Franke	31.57	0	122	0	0	0	0	0

Distance: 91 yds SCT: 44 secs **Level 5 Enthusiast** (12) 8 inch Judge: JoLee Yeddo

Place	Armband	CPE ID	Call Name	Handler	Time	TF	WCs	Bar	Off	Oth	Maj	Tot
1	12002 T	20873-02	Sophie	M. Carlin	46.66	2	122	0	1	0	0	7

Distance: 91 yds SCT: 44 secs **Level 5 Enthusiast** (16) 12 inch Judge: JoLee Yeddo

Place	Armband	CPE ID	Call Name	Handler	Time	TF	WCs	Bar	Off	Oth	Maj	Tot
1Q	16004 T	22581-04	Little Man	L. Bollenbach	39.97	0	122	0	0	0	0	0

Distance: 91 yds SCT: 39 secs **Level 5 Enthusiast** (20) 16 inch Judge: JoLee Yeddo

Place	Armband	CPE ID	Call Name	Handler	Time	TF	WCs	Bar	Off	Oth	Maj	Tot
1	20015 T	27736-01	Jethro	R. Thompson	39.06	0	12	1	2	0	0	15

Distance: 91 yds SCT: 44 secs **Level 5 Specialist** (16) 8 inch Judge: JoLee Yeddo

Place	Armband	CPE ID	Call Name	Handler	Time	TF	WCs	Bar	Off	Oth	Maj	Tot
	16010 S	23210-01	Maisie	R. Tucker	Absent							

Distance: 91 yds SCT: 44 secs **Level 5 Specialist** (20) 12 inch Judge: JoLee Yeddo

Place	Armband	CPE ID	Call Name	Handler	Time	TF	WCs	Bar	Off	Oth	Maj	Tot
1Q	20006 S	10917-02	Abby	K. Mathieson	43.83	0	122	0	0	0	0	0

Skyline Agility Club (Club #44)

Saturday, November 19, 2022

Jackpot

Opening: 30 secs Gamble: 18 secs **Level 1 Regular/Veteran** 20 inch Judge: JoLee Yeddo
Place Armband CPE ID Call Name Handler Time 1Pt 3Pt 5Pt 7Pt Gam GC Score

20009 24743-04 **Ellie** C. Jersey NT 0 0 0 0

Opening: 30 secs Gamble: 18 secs **Level 1 Enthusiast** (20) 16 inch Judge: JoLee Yeddo
Place Armband CPE ID Call Name Handler Time 1Pt 3Pt 5Pt 7Pt Gam GC Score

20018 T 22118-03 **Gator** K. Kalfas NT 0 0 0 0

Opening: 35 secs Gamble: 20 secs **Level 2 Enthusiast** (16) 12 inch Judge: JoLee Yeddo
Place Armband CPE ID Call Name Handler Time 1Pt 3Pt 5Pt 7Pt Gam GC Score

1Q 16013 T 11138-04 **Arya** J. Yeddo 47.07 10 4 1 0 20 Y 47

Opening: 30 secs Gamble: 18 secs **Level 2 Enthusiast** (20) 16 inch Judge: JoLee Yeddo
Place Armband CPE ID Call Name Handler Time 1Pt 3Pt 5Pt 7Pt Gam GC Score

20002 T 31306-01 **Tillie** A. Selzner Absent

Opening: 30 secs Gamble: 18 secs **Level 2 Enthusiast** (24) 20 inch Judge: JoLee Yeddo
Place Armband CPE ID Call Name Handler Time 1Pt 3Pt 5Pt 7Pt Gam GC Score

24001 T 33373-01 **Loki** L. Gambill Not Scored

Skyline Agility Club (Club #44)

Saturday, November 19, 2022

Jackpot

Opening: 30 secs Gamble: 20 secs **Level 3 Regular/Veteran** 16 inch Judge: JoLee Yeddo
Place Armband CPE ID Call Name Handler Time 1Pt 3Pt 5Pt 7Pt Gam GC Score
16012 18274-04 **Aurora** D. Coglietta Not Scored

Skyline Agility Club (Club #44)

Saturday, November 19, 2022

Jackpot

Opening: 35 secs Gamble: 22 secs **Level 5 Regular/Veteran** 8 inch Judge: JoLee Yeddo
 Place Armband CPE ID Call Name Handler Time 1Pt 3Pt 5Pt 7Pt Gam GC Score
1Q 8004 20344-02 **Junior** N. Kowal 48.98 3 2 3 0 20 Y 44

Opening: 35 secs Gamble: 22 secs **Level 5 Regular/Veteran** 12 inch Judge: JoLee Yeddo
 Place Armband CPE ID Call Name Handler Time 1Pt 3Pt 5Pt 7Pt Gam GC Score
 12010 18198-03 **Jennie** S. Budd NT 0 0 0 0
 12005 07934-05 **Brodie** L. Henry Absent
1 12007 19315-03 **Myles** K. Krajcovic 54.99 8 3 2 0 27

Opening: 30 secs Gamble: 20 secs **Level 5 Regular/Veteran** 16 inch Judge: JoLee Yeddo
 Place Armband CPE ID Call Name Handler Time 1Pt 3Pt 5Pt 7Pt Gam GC Score
 16001 06411-04 **Jedi** J. Hamilton NT 0 0 0 0

Opening: 30 secs Gamble: 20 secs **Level 5 Regular/Veteran** 20 inch Judge: JoLee Yeddo
 Place Armband CPE ID Call Name Handler Time 1Pt 3Pt 5Pt 7Pt Gam GC Score
 20011 24743-03 **Gibbs** C. Jersey NT 0 0 0 0
 20005 25468-04 **Breeze** J. Franke NT 0 0 0 0
 20013 V 13603-02 **Dasher** T. Travis NT 0 0 0 0
 20016 V 14850-06 **Innes** K. Mazarak Absent

Opening: 35 secs Gamble: 22 secs **Level C Regular/Veteran** 8 inch Judge: JoLee Yeddo
 Place Armband CPE ID Call Name Handler Time 1Pt 3Pt 5Pt 7Pt Gam GC Score
1 8002 26964-01 **Lilly** K. Wasko 52.14 4 2 3 0 12 37
2 8003 08144-05 **Mia** M. Buchel 54.05 4 2 3 0 2 27

Opening: 30 secs Gamble: 20 secs **Level C Regular/Veteran** 16 inch Judge: JoLee Yeddo
 Place Armband CPE ID Call Name Handler Time 1Pt 3Pt 5Pt 7Pt Gam GC Score
3 16002 04813-06 **Dori Blue** B. Hartman 37.12 9 5 4 0 44
1Q 16007 30105-01 **Jem** M. Samuels 47.87 2 4 4 0 20 Y 54
2Q 16011 18274-03 **Cooper** D. Coglietta 38.68 4 5 2 0 20 Y 49
4 16016 04813-05 **Ici Blue** B. Hartman 48.98 7 5 4 0 42

Opening: 30 secs Gamble: 20 secs **Level C Regular/Veteran** 20 inch Judge: JoLee Yeddo
 Place Armband CPE ID Call Name Handler Time 1Pt 3Pt 5Pt 7Pt Gam GC Score
3Q 20021 10804-03 **Fergie** S. Cappiello 41.75 5 1 4 0 20 Y 48

1Q	20014	12713-03	Andy	L. Garfinkel	43.14	5	2	4	0	20	Y	51
2Q	20001	04813-07	Aggi Jo	B. Hartman	42.07	5	3	3	0	20	Y	49
	20004 V	10804-02	Bosworth	S. Cappiello	51.00	4	2	4	0	6		36
4Q	20003 V	25468-03	Spark	J. Franke	50.95	4	2	3	0	20	Y	45

Opening: 35 secs Gamble: 22 secs **Level 5 Enthusiast** (12) 8 inch Judge: JoLee Yeddo
Place Armband CPE ID Call Name Handler Time 1Pt 3Pt 5Pt 7Pt Gam GC Score
12002 T 20873-02 **Sophie** M. Carlin NT 0 0 0 0

Opening: 35 secs Gamble: 22 secs **Level 5 Enthusiast** (16) 12 inch Judge: JoLee Yeddo
Place Armband CPE ID Call Name Handler Time 1Pt 3Pt 5Pt 7Pt Gam GC Score
1 16004 T 22581-04 **Little Man** L. Bollenbach 58.42 6 3 3 0 12 42

Opening: 30 secs Gamble: 20 secs **Level 5 Enthusiast** (20) 16 inch Judge: JoLee Yeddo
Place Armband CPE ID Call Name Handler Time 1Pt 3Pt 5Pt 7Pt Gam GC Score
1Q 20015 T 27736-01 **Jethro** R. Thompson 50.48 8 3 2 0 20 Y 47

Opening: 35 secs Gamble: 22 secs **Level 5 Specialist** (16) 8 inch Judge: JoLee Yeddo
Place Armband CPE ID Call Name Handler Time 1Pt 3Pt 5Pt 7Pt Gam GC Score
16010 S 23210-01 **Maisie** R. Tucker Absent

Skyline Agility Club (Club #44)

Saturday, November 19, 2022

FullHouse

Total Time: 35 secs **Level 2 Regular/Veteran** 16 inch Judge: JoLee Yeddo
 Place Armband CPE ID Call Name Handler Time 1Pt 3Pt 5Pt TFlts Total

1 16019 33472-01 **KiKi Party** K. McNeil 34.81 3 4 0 0 15

Total Time: 35 secs **Level 2 Regular/Veteran** 20 inch Judge: JoLee Yeddo
 Place Armband CPE ID Call Name Handler Time 1Pt 3Pt 5Pt TFlts Total

2 20009 24743-04 **Ellie** C. Jersey 37.43 1 1 0 2 2

1 20008 32620-01 **Wallace** B. Tomeck 38.86 3 2 1 3 11

Total Time: 35 secs **Level 3 Regular/Veteran** 16 inch Judge: JoLee Yeddo
 Place Armband CPE ID Call Name Handler Time 1Pt 3Pt 5Pt TFlts Total

16012 18274-04 **Aurora** D. Coglietta NT 0 0 0 0

Total Time: 40 secs **Level 5 Regular/Veteran** 12 inch Judge: JoLee Yeddo
 Place Armband CPE ID Call Name Handler Time 1Pt 3Pt 5Pt TFlts Total

1Q 12010 18198-03 **Jennie** S. Budd 32.83 6 3 2 0 25

Total Time: 35 secs **Level 5 Regular/Veteran** 16 inch Judge: JoLee Yeddo
 Place Armband CPE ID Call Name Handler Time 1Pt 3Pt 5Pt TFlts Total

1 16001 06411-04 **Jedi** J. Hamilton 21.41 3 4 1 0 20

Total Time: 35 secs **Level 5 Regular/Veteran** 20 inch Judge: JoLee Yeddo
 Place Armband CPE ID Call Name Handler Time 1Pt 3Pt 5Pt TFlts Total

1Q 20005 25468-04 **Breeze** J. Franke 31.81 6 4 2 0 28

3Q 20011 24743-03 **Gibbs** C. Jersey 36.66 5 2 3 1 25

20016 V 14850-06 **Innes** K. Mazarak Absent

4 20013 V 13603-02 **Dasher** T. Travis 34.16 8 2 2 0 24

2Q 20003 V 25468-03 **Spark** J. Franke 32.84 7 3 2 0 26

Total Time: 40 secs **Level C Regular/Veteran** 8 inch Judge: JoLee Yeddo
 Place Armband CPE ID Call Name Handler Time 1Pt 3Pt 5Pt TFlts Total

2Q 8002 26964-01 **Lilly** K. Wasko 23.74 4 2 3 0 25

3 8003 08144-05 **Mia** M. Buchel 44.55 3 1 2 4 12

1Q 8004 20344-02 **Junior** N. Kowal 39.08 3 4 3 0 30

Total Time: 40 secs **Level C Regular/Veteran** 12 inch Judge: JoLee Yeddo
 Place Armband CPE ID Call Name Handler Time 1Pt 3Pt 5Pt TFflts Total
1Q 12007 19315-03 **Myles** K. Krajcovic 39.03 7 6 2 0 35

Total Time: 35 secs **Level C Regular/Veteran** 16 inch Judge: JoLee Yeddo
 Place Armband CPE ID Call Name Handler Time 1Pt 3Pt 5Pt TFflts Total
2Q 16002 04813-06 **Dori Blue** B. Hartman 22.18 6 2 5 0 37
4Q 16011 18274-03 **Cooper** D. Coglietta 37.45 3 5 2 2 26
1Q 16007 30105-01 **Jem** M. Samuels 32.80 7 4 4 0 39
3Q 16016 04813-05 **Ici Blue** B. Hartman 27.57 5 2 5 0 36

Total Time: 35 secs **Level C Regular/Veteran** 20 inch Judge: JoLee Yeddo
 Place Armband CPE ID Call Name Handler Time 1Pt 3Pt 5Pt TFflts Total
2Q 20021 10804-03 **Fergie** S. Cappiello 36.13 7 5 3 1 36
1Q 20014 12713-03 **Andy** L. Garfinkel 33.45 6 5 4 0 41
3Q 20001 04813-07 **Aggi Jo** B. Hartman 32.62 6 2 4 0 32
4 20004 V 10804-02 **Bosworth** S. Cappiello 37.56 4 4 2 2 24

Total Time: 40 secs **Level 1 Enthusiast** (12) 8 inch Judge: JoLee Yeddo
 Place Armband CPE ID Call Name Handler Time 1Pt 3Pt 5Pt TFflts Total
 12001 T 20873-03 **Oliver** M. Carlin NT 0 0 0 0 0

Total Time: 35 secs **Level 1 Enthusiast** (20) 16 inch Judge: JoLee Yeddo
 Place Armband CPE ID Call Name Handler Time 1Pt 3Pt 5Pt TFflts Total
1 20018 T 22118-03 **Gator** K. Kalfas 13.22 3 1 1 0 11

Total Time: 35 secs **Level 2 Enthusiast** (20) 16 inch Judge: JoLee Yeddo
 Place Armband CPE ID Call Name Handler Time 1Pt 3Pt 5Pt TFflts Total
 20002 T 31306-01 **Tillie** A. Selzner Absent

Total Time: 40 secs **Level 5 Enthusiast** (12) 8 inch Judge: JoLee Yeddo
 Place Armband CPE ID Call Name Handler Time 1Pt 3Pt 5Pt TFflts Total
1 12002 T 20873-02 **Sophie** M. Carlin 33.56 3 3 1 0 17

Total Time: 40 secs **Level 5 Enthusiast** (16) 12 inch Judge: JoLee Yeddo
 Place Armband CPE ID Call Name Handler Time 1Pt 3Pt 5Pt TFflts Total
1Q 16004 T 22581-04 **Little Man** L. Bollenbach 35.72 5 4 3 0 32

Total Time: 35 secs **Level 5 Enthusiast** (20) 16 inch Judge: JoLee Yeddo
 Place Armband CPE ID Call Name Handler Time 1Pt 3Pt 5Pt TFlts Total
 1 20015 T 27736-01 **Jethro** R. Thompson 38.22 2 4 2 3 21

Total Time: 40 secs **Level 5 Specialist** (16) 8 inch Judge: JoLee Yeddo
 Place Armband CPE ID Call Name Handler Time 1Pt 3Pt 5Pt TFlts Total
 16010 S 23210-01 **Maisie** R. Tucker Absent

Total Time: 40 secs **Level 5 Specialist** (20) 12 inch Judge: JoLee Yeddo
 Place Armband CPE ID Call Name Handler Time 1Pt 3Pt 5Pt TFlts Total
 1Q 20006 S 10917-02 **Abby** K. Mathieson 38.84 4 3 2 0 23

Skyline Agility Club (Club #44)

Saturday, November 19, 2022

Standard

Distance: 167 yds SCT: 71 secs **Level 5 Regular/Veteran** 12 inch Judge: JoLee Yeddo

Place	Armband	CPE ID	Call Name	Handler	Time	TFlts	Bar	Off	Oth	Maj	Total
1Q	12010	18198-03	Jennie	S. Budd	69.64	0	0	0	1	0	5
3	12005	07934-05	Brodie	L. Henry	69.20	0	1	2	2	1	40
2	12007	19315-03	Myles	K. Krajcovic	64.28	0	0	1	1	1	25

Distance: 167 yds SCT: 61 secs **Level 5 Regular/Veteran** 16 inch Judge: JoLee Yeddo

Place	Armband	CPE ID	Call Name	Handler	Time	TFlts	Bar	Off	Oth	Maj	Total
2Q	16001	06411-04	Jedi	J. Hamilton	55.26	0	0	0	0	0	0
1Q	16011	18274-03	Cooper	D. Coglietta	37.96	0	0	0	0	0	0

Distance: 167 yds SCT: 61 secs **Level 5 Regular/Veteran** 20 inch Judge: JoLee Yeddo

Place	Armband	CPE ID	Call Name	Handler	Time	TFlts	Bar	Off	Oth	Maj	Total
1Q	20011	24743-03	Gibbs	C. Jersey	53.78	0	0	0	0	0	0
2	20005	25468-04	Breeze	J. Franke	49.00	0	0	0	0	1	15
	20004 V	10804-02	Bosworth	S. Cappiello	NT	0	0	0	0	0	0
	20016 V	14850-06	Innes	K. Mazarak	Absent						
	20013 V	13603-02	Dasher	T. Travis	NT	0	0	0	0	0	0

Distance: 167 yds SCT: 71 secs **Level C Regular/Veteran** 8 inch Judge: JoLee Yeddo

Place	Armband	CPE ID	Call Name	Handler	Time	TFlts	Bar	Off	Oth	Maj	Total
1Q	8002	26964-01	Lilly	K. Wasko	52.94	0	0	0	0	0	0
2Q	8003	08144-05	Mia	M. Buchel	63.21	0	0	0	0	0	0
3Q	8004	20344-02	Junior	N. Kowal	70.57	0	0	0	0	0	0

Distance: 167 yds SCT: 61 secs **Level C Regular/Veteran** 16 inch Judge: JoLee Yeddo

Place	Armband	CPE ID	Call Name	Handler	Time	TFlts	Bar	Off	Oth	Maj	Total
3	16002	04813-06	Dori Blue	B. Hartman	72.01	11	0	0	0	0	11
1Q	16007	30105-01	Jem	M. Samuels	34.48	0	0	0	0	0	0
2Q	16016	04813-05	Ici Blue	B. Hartman	35.03	0	0	0	0	0	0

Distance: 167 yds SCT: 61 secs **Level C Regular/Veteran** 20 inch Judge: JoLee Yeddo

Place	Armband	CPE ID	Call Name	Handler	Time	TFlts	Bar	Off	Oth	Maj	Total
4	20021	10804-03	Fergie	S. Cappiello	46.54	0	2	0	0	0	10
3	20014	12713-03	Andy	L. Garfinkel	69.40	8	0	0	0	0	8
1Q	20001	04813-07	Aggi Jo	B. Hartman	44.90	0	0	0	0	0	0

2Q 20003 V 25468-03 **Spark** J. Franke 54.04 0 0 0 0 0 0

Distance: 167 yds SCT: 76 secs **Level 5 Enthusiast** (12) 8 inch Judge: JoLee Yeddo
Place Armband CPE ID Call Name Handler Time TFlts Bar Off Oth Maj Total

1Q 12002 T 20873-02 **Sophie** M. Carlin 80.66 4 0 0 0 0 4

Distance: 167 yds SCT: 76 secs **Level 5 Enthusiast** (16) 12 inch Judge: JoLee Yeddo
Place Armband CPE ID Call Name Handler Time TFlts Bar Off Oth Maj Total

16004 T 22581-04 **Little Man** L. Bollenbach NT 0 0 0 0 0

Distance: 167 yds SCT: 66 secs **Level 5 Enthusiast** (20) 16 inch Judge: JoLee Yeddo
Place Armband CPE ID Call Name Handler Time TFlts Bar Off Oth Maj Total

1 20015 T 27736-01 **Jethro** R. Thompson 59.65 0 0 3 1 2 50

Distance: 167 yds SCT: 76 secs **Level 5 Specialist** (16) 8 inch Judge: JoLee Yeddo
Place Armband CPE ID Call Name Handler Time TFlts Bar Off Oth Maj Total

16010 S 23210-01 **Maisie** R. Tucker Absent

Skyline Agility Club (Club #44)

Saturday, November 19, 2022

Standard

Distance: 143 yds SCT: 58 secs **Level 3 Regular/Veteran** 16 inch Judge: JoLee Yeddo
Place Armband CPE ID Call Name Handler Time TFlts Bar Off Oth Maj Total
1 16012 18274-04 **Aurora** D. Coglietta 40.91 0 0 0 0 2 30

Distance: 143 yds SCT: 58 secs **Level 3 Regular/Veteran** 20 inch Judge: JoLee Yeddo
Place Armband CPE ID Call Name Handler Time TFlts Bar Off Oth Maj Total
1Q 20008 32620-01 **Wallace** B. Tomeck 51.39 0 0 0 1 0 5

Skyline Agility Club (Club #44)

Saturday, November 19, 2022

Standard

Distance: 143 yds SCT: 64 secs **Level 2 Regular/Veteran** 16 inch Judge: JoLee Yeddo
Place Armband CPE ID Call Name Handler Time TFlts Bar Off Oth Maj Total
1Q 16019 33472-01 **KiKi Party** K. McNeil 42.08 0 0 0 0 0 0

Distance: 143 yds SCT: 74 secs **Level 2 Enthusiast** (16) 12 inch Judge: JoLee Yeddo
Place Armband CPE ID Call Name Handler Time TFlts Bar Off Oth Maj Total
1 16013 T 11138-04 **Arya** J. Yeddo 64.14 0 0 1 0 1 20

Skyline Agility Club (Club #44)

Saturday, November 19, 2022

Standard

Distance: 110 yds SCT: 49 secs **Level 1 Regular/Veteran** 20 inch Judge: JoLee Yeddo
Place Armband CPE ID Call Name Handler Time TFlts Bar Off Oth Maj Total

20009 24743-04 **Ellie** C. Jersey NT 0 0 0 0 0

Distance: 110 yds SCT: 54 secs **Level 1 Enthusiast** (20) 16 inch Judge: JoLee Yeddo
Place Armband CPE ID Call Name Handler Time TFlts Bar Off Oth Maj Total

20002 T 31306-01 **Tillie** A. Selzner Absent

20018 T 22118-03 **Gator** K. Kalfas NT 0 0 0 0 0

Skyline Agility Club (Club #44)

Sunday, November 20, 2022

FullHouse

Total Time: 40 secs **Level 1 Regular/Veteran** 8 inch Judge: JoLee Yeddo
Place Armband CPE ID Call Name Handler Time 1Pt 3Pt 5Pt TFlts Total

1Q 8001 12038-11 **Lily** B. Garstin 38.35 5 4 1 0 22

Total Time: 35 secs **Level 2 Regular/Veteran** 20 inch Judge: JoLee Yeddo
Place Armband CPE ID Call Name Handler Time 1Pt 3Pt 5Pt TFlts Total

1 20020 33736-01 **Apollo** S. Khera 36.86 2 2 2 1 17

2 20010 33736-02 **Angel** S. Khera 44.02 7 1 2 9 11

Total Time: 35 secs **Level 2 Regular/Veteran** 16 inch Judge: JoLee Yeddo
Place Armband CPE ID Call Name Handler Time 1Pt 3Pt 5Pt TFlts Total

1 16009 10807-02 **Luna** R. Lorig 42.80 1 2 0 7 0

Total Time: 40 secs **Level 2 Regular/Veteran** 12 inch Judge: JoLee Yeddo
Place Armband CPE ID Call Name Handler Time 1Pt 3Pt 5Pt TFlts Total

2 12006 32994-01 **Ipsa Facto** M. Martin 39.43 4 2 2 0 20

1Q 12004 13627-02 **Ollie** S. Rudy 27.62 6 4 3 0 33

Total Time: 35 secs **Level 3 Regular/Veteran** 16 inch Judge: JoLee Yeddo
Place Armband CPE ID Call Name Handler Time 1Pt 3Pt 5Pt TFlts Total

1Q 16012 18274-04 **Aurora** D. Coglietta 38.63 3 5 3 3 30

Total Time: 40 secs **Level 4 Regular/Veteran** 8 inch Judge: JoLee Yeddo
Place Armband CPE ID Call Name Handler Time 1Pt 3Pt 5Pt TFlts Total

1Q 8005 12038-10 **Dennis** B. Garstin 33.18 7 5 3 0 37

Total Time: 35 secs **Level 5 Regular/Veteran** 20 inch Judge: JoLee Yeddo
Place Armband CPE ID Call Name Handler Time 1Pt 3Pt 5Pt TFlts Total

1Q 20005 25468-04 **Breeze** J. Franke 26.67 5 4 3 0 32

2Q 20003 V 25468-03 **Spark** J. Franke 31.04 5 4 3 0 32

Total Time: 35 secs **Level 5 Regular/Veteran** 16 inch Judge: JoLee Yeddo
Place Armband CPE ID Call Name Handler Time 1Pt 3Pt 5Pt TFlts Total

1Q 16008 31804-01 **Kenai** C. Felice 36.90 7 2 5 1 37

2Q	16006	10911-06	Jack	A. Heupel	32.37	4	3	4	0	33
4Q	16001	06411-04	Jedi	J. Hamilton	37.15	3	4	3	2	28
3Q	16015 V	12633-08	Justice	S. Herr	40.02	5	4	4	5	32

Total Time: 40 secs Level 5 Regular/Veteran					12	inch Judge: JoLee Yeddo				
Place	Armband	CPE ID	Call Name	Handler	Time	1Pt	3Pt	5Pt	TFlts	Total
	12010	18198-03	Jennie	S. Budd	Absent					

Total Time: 35 secs Level C Regular/Veteran					20	inch Judge: JoLee Yeddo				
Place	Armband	CPE ID	Call Name	Handler	Time	1Pt	3Pt	5Pt	TFlts	Total
2Q	20021	10804-03	Fergie	S. Cappiello	31.03	5	4	3	0	32
3Q	20017	05450-06	Pandemo...	D. Piroha	26.37	5	3	3	0	29
1Q	20014	12713-03	Andy	L. Garfinkel	33.12	6	4	4	0	38
4Q	20004 V	10804-02	Bosworth	S. Cappiello	33.97	5	3	3	0	29

Total Time: 35 secs Level C Regular/Veteran					16	inch Judge: JoLee Yeddo				
Place	Armband	CPE ID	Call Name	Handler	Time	1Pt	3Pt	5Pt	TFlts	Total
1Q	16007	30105-01	Jem	M. Samuels	34.33	7	3	5	0	41
3Q	16011	18274-03	Cooper	D. Coglietta	32.70	4	5	3	0	34
2Q	16014 V	01417-06	GooRoo	V. Damant	26.74	7	4	3	0	34

Total Time: 40 secs Level C Regular/Veteran					8	inch Judge: JoLee Yeddo				
Place	Armband	CPE ID	Call Name	Handler	Time	1Pt	3Pt	5Pt	TFlts	Total
1Q	8004	20344-02	Junior	N. Kowal	41.43	5	4	3	1	31
2Q	8002	26964-01	Lilly	K. Wasko	23.97	5	2	3	0	26

Total Time: 35 secs Level 1 Enthusiast (20)					16	inch Judge: JoLee Yeddo				
Place	Armband	CPE ID	Call Name	Handler	Time	1Pt	3Pt	5Pt	TFlts	Total
1	20018 T	22118-03	Gator	K. Kalfas	46.74	3	4	1	11	9

Total Time: 40 secs Level 1 Enthusiast (12)					8	inch Judge: JoLee Yeddo				
Place	Armband	CPE ID	Call Name	Handler	Time	1Pt	3Pt	5Pt	TFlts	Total
1	12001 T	20873-03	Oliver	M. Carlin	39.98	5	2	1	0	16

Total Time: 35 secs Level 2 Enthusiast (20)					16	inch Judge: JoLee Yeddo				
Place	Armband	CPE ID	Call Name	Handler	Time	1Pt	3Pt	5Pt	TFlts	Total
1Q	20012 T	01417-07	Heathcliff	V. Damant	33.61	5	2	3	0	26

Total Time: 40 secs **Level 2 Enthusiast** (16) 12 inch Judge: JoLee Yeddo
 Place Armband CPE ID Call Name Handler Time 1Pt 3Pt 5Pt TFlts Total
1Q 16013 T 11138-04 **Arya** J. Yeddo 35.00 7 4 3 0 34

Total Time: 40 secs **Level 5 Enthusiast** (12) 8 inch Judge: JoLee Yeddo
 Place Armband CPE ID Call Name Handler Time 1Pt 3Pt 5Pt TFlts Total
1 12002 T 20873-02 **Sophie** M. Carlin 44.78 3 2 3 4 20
 12008 T 05432-03 **Susie** B. Ogonowski Absent

Total Time: 40 secs **Level C Enthusiast** (16) 12 inch Judge: JoLee Yeddo
 Place Armband CPE ID Call Name Handler Time 1Pt 3Pt 5Pt TFlts Total
1Q 16005 T 30612-02 **Hazel** S. Johnson 42.67 3 4 4 2 33

Total Time: 35 secs **Level 5 Specialist** (24) 16 inch Judge: JoLee Yeddo
 Place Armband CPE ID Call Name Handler Time 1Pt 3Pt 5Pt TFlts Total
1Q 24002 S 05450-04 **Mayhem** D. Piroha 27.00 5 3 3 0 29

Total Time: 40 secs **Level 5 Specialist** (20) 12 inch Judge: JoLee Yeddo
 Place Armband CPE ID Call Name Handler Time 1Pt 3Pt 5Pt TFlts Total
1Q 20006 S 10917-02 **Abby** K. Mathieson 38.03 7 3 3 0 31

Skyline Agility Club (Club #44)

Sunday, November 20, 2022

Jackpot

Opening: 35 secs Gamble: 22 secs **Level 1 Regular/Veteran** 12 inch Judge: JoLee Yeddo
Place Armband CPE ID Call Name Handler Time 1Pt 3Pt 5Pt 7Pt Gam GC Score

1 12006 32994-01 **Ipsos Facto** M. Martin 61.19 8 4 2 0 30

Opening: 35 secs Gamble: 22 secs **Level 1 Regular/Veteran** 8 inch Judge: JoLee Yeddo
Place Armband CPE ID Call Name Handler Time 1Pt 3Pt 5Pt 7Pt Gam GC Score

1 8001 12038-11 **Lily** B. Garstin 62.74 4 3 5 0 38

Opening: 30 secs Gamble: 20 secs **Level 2 Regular/Veteran** 20 inch Judge: JoLee Yeddo
Place Armband CPE ID Call Name Handler Time 1Pt 3Pt 5Pt 7Pt Gam GC Score

2Q 20020 33736-01 **Apollo** S. Khera 50.34 5 2 2 0 20 Y 41

1Q 20010 33736-02 **Angel** S. Khera 46.99 3 2 3 0 20 Y 44

Opening: 30 secs Gamble: 20 secs **Level 2 Regular/Veteran** 16 inch Judge: JoLee Yeddo
Place Armband CPE ID Call Name Handler Time 1Pt 3Pt 5Pt 7Pt Gam GC Score

1Q 16009 10807-02 **Luna** R. Lorig 40.47 6 3 1 0 20 Y 40

Opening: 35 secs Gamble: 22 secs **Level 2 Regular/Veteran** 12 inch Judge: JoLee Yeddo
Place Armband CPE ID Call Name Handler Time 1Pt 3Pt 5Pt 7Pt Gam GC Score

1Q 12004 13627-02 **Ollie** S. Rudy 45.98 7 5 4 0 20 Y 62

Opening: 30 secs Gamble: 20 secs **Level 3 Regular/Veteran** 16 inch Judge: JoLee Yeddo
Place Armband CPE ID Call Name Handler Time 1Pt 3Pt 5Pt 7Pt Gam GC Score

1 16012 18274-04 **Aurora** D. Coglietta 49.09 5 4 1 0 22

Opening: 35 secs Gamble: 22 secs **Level 3 Regular/Veteran** 8 inch Judge: JoLee Yeddo
Place Armband CPE ID Call Name Handler Time 1Pt 3Pt 5Pt 7Pt Gam GC Score

1 8005 12038-10 **Dennis** B. Garstin 62.12 4 8 4 0 48

Opening: 30 secs Gamble: 20 secs **Level 5 Regular/Veteran** 20 inch Judge: JoLee Yeddo
Place Armband CPE ID Call Name Handler Time 1Pt 3Pt 5Pt 7Pt Gam GC Score

1Q 20005 25468-04 **Breeze** J. Franke 43.08 4 2 5 0 20 Y 55

Opening: 30 secs Gamble: 20 secs Level 5 Regular/Veteran 16 inch Judge: JoLee Yeddo												
Place	Armband	CPE ID	Call Name	Handler	Time	1Pt	3Pt	5Pt	7Pt	Gam	GC	Score
4	16008	31804-01	Kenai	C. Felice	46.48	6	5	3	0			36
3	16006	10911-06	Jack	A. Heupel	47.13	6	6	3	0			39
1Q	16001	06411-04	Jedi	J. Hamilton	44.46	4	2	4	0	20	Y	50
2	16015 V	12633-08	Justice	S. Herr	54.05	5	3	5	0	20	Y	59

Opening: 35 secs Gamble: 22 secs Level 5 Regular/Veteran 12 inch Judge: JoLee Yeddo												
Place	Armband	CPE ID	Call Name	Handler	Time	1Pt	3Pt	5Pt	7Pt	Gam	GC	Score
	12010	18198-03	Jennie	S. Budd	Absent							
2Q	12009	12038-09	Halle	B. Garstin	56.59	5	2	4	0	20	Y	51
1Q	12005	07934-05	Brodie	L. Henry	45.81	3	3	4	0	20	Y	52

Opening: 30 secs Gamble: 20 secs Level C Regular/Veteran 20 inch Judge: JoLee Yeddo												
Place	Armband	CPE ID	Call Name	Handler	Time	1Pt	3Pt	5Pt	7Pt	Gam	GC	Score
Q	20021	10804-03	Fergie	S. Cappiello	40.10	3	4	3	0	20	Y	50
3Q	20017	05450-06	Pandemo...	D. Piroha	42.58	4	2	5	0	20	Y	55
4Q	20014	12713-03	Andy	L. Garfinkel	50.90	5	3	4	0	20	Y	54
1Q	20004 V	10804-02	Bosworth	S. Cappiello	45.69	3	3	6	0	20	Y	62
2Q	20003 V	25468-03	Spark	J. Franke	42.38	4	2	5	0	20	Y	55

Opening: 30 secs Gamble: 20 secs Level C Regular/Veteran 16 inch Judge: JoLee Yeddo												
Place	Armband	CPE ID	Call Name	Handler	Time	1Pt	3Pt	5Pt	7Pt	Gam	GC	Score
2	16007	30105-01	Jem	M. Samuels	44.76	7	6	4	0			45
3	16011	18274-03	Cooper	D. Coglietta	45.94	3	5	4	0			38
1Q	16014 V	01417-06	GooRoo	V. Damant	40.01	5	2	5	0	20	Y	56

Opening: 35 secs Gamble: 22 secs Level C Regular/Veteran 12 inch Judge: JoLee Yeddo												
Place	Armband	CPE ID	Call Name	Handler	Time	1Pt	3Pt	5Pt	7Pt	Gam	GC	Score
1Q	12003	16325-04	Disney	D. Sroczynski	47.88	4	2	4	0	20	Y	50

Opening: 35 secs Gamble: 22 secs Level C Regular/Veteran 8 inch Judge: JoLee Yeddo												
Place	Armband	CPE ID	Call Name	Handler	Time	1Pt	3Pt	5Pt	7Pt	Gam	GC	Score
2Q	8004	20344-02	Junior	N. Kowal	52.07	4	1	5	0	20	Y	52
1Q	8002	26964-01	Lilly	K. Wasko	51.26	5	2	5	0	20	Y	56

Opening: 30 secs Gamble: 20 secs Level 1 Enthusiast (20) 16 inch Judge: JoLee Yeddo												
Place	Armband	CPE ID	Call Name	Handler	Time	1Pt	3Pt	5Pt	7Pt	Gam	GC	Score
1	20018 T	22118-03	Gator	K. Kalfas	52.66	3	4	0	0			15

Opening: 30 secs Gamble: 20 secs **Level 2 Enthusiast** (20) 16 inch Judge: JoLee Yeddo
 Place Armband CPE ID Call Name Handler Time 1Pt 3Pt 5Pt 7Pt Gam GC Score
1Q 20012 T 01417-07 **Heathcliff** V. Damant 43.62 5 1 4 0 20 Y 48

Opening: 35 secs Gamble: 22 secs **Level 2 Enthusiast** (16) 12 inch Judge: JoLee Yeddo
 Place Armband CPE ID Call Name Handler Time 1Pt 3Pt 5Pt 7Pt Gam GC Score
 16003 T 32416-01 **Lacey** E. Nadeau NT 0 0 0 0

Opening: 35 secs Gamble: 22 secs **Level 5 Enthusiast** (12) 8 inch Judge: JoLee Yeddo
 Place Armband CPE ID Call Name Handler Time 1Pt 3Pt 5Pt 7Pt Gam GC Score
 12008 T 05432-03 **Susie** B. Ogonowski Absent
1Q 12002 T 20873-02 **Sophie** M. Carlin 50.99 2 2 3 0 20 Y 43

Opening: 35 secs Gamble: 22 secs **Level C Enthusiast** (16) 12 inch Judge: JoLee Yeddo
 Place Armband CPE ID Call Name Handler Time 1Pt 3Pt 5Pt 7Pt Gam GC Score
1Q 16005 T 30612-02 **Hazel** S. Johnson 49.41 7 2 4 0 20 Y 53

Opening: 30 secs Gamble: 20 secs **Level 5 Specialist** (24) 16 inch Judge: JoLee Yeddo
 Place Armband CPE ID Call Name Handler Time 1Pt 3Pt 5Pt 7Pt Gam GC Score
1Q 24002 S 05450-04 **Mayhem** D. Piroha 43.16 4 1 5 0 20 Y 52

Skyline Agility Club (Club #44)

Sunday, November 20, 2022

Colors

Distance: 86 yds SCT: 37 secs **Level 3 Regular/Veteran** 16 inch Judge: JoLee Yeddo
 Place Armband CPE ID Call Name Handler Time TFlts Bar Off Oth Maj Total

2Q 16012 18274-04 **Aurora** D. Coglietta 29.14 0 0 0 0 0 0
1Q 16001 06411-04 **Jedi** J. Hamilton 21.88 0 0 0 0 0 0

Distance: 86 yds SCT: 42 secs **Level 3 Regular/Veteran** 12 inch Judge: JoLee Yeddo
 Place Armband CPE ID Call Name Handler Time TFlts Bar Off Oth Maj Total

1Q 12004 13627-02 **Ollie** S. Rudy 30.12 0 0 0 0 0 0

Distance: 86 yds SCT: 42 secs **Level 3 Regular/Veteran** 8 inch Judge: JoLee Yeddo
 Place Armband CPE ID Call Name Handler Time TFlts Bar Off Oth Maj Total

1 8005 12038-10 **Dennis** B. Garstin 26.60 0 1 0 0 0 5

Distance: 86 yds SCT: 32 secs **Level 5 Regular/Veteran** 20 inch Judge: JoLee Yeddo
 Place Armband CPE ID Call Name Handler Time TFlts Bar Off Oth Maj Total

1Q 20005 25468-04 **Breeze** J. Franke 22.26 0 0 0 0 0 0

Distance: 86 yds SCT: 32 secs **Level 5 Regular/Veteran** 16 inch Judge: JoLee Yeddo
 Place Armband CPE ID Call Name Handler Time TFlts Bar Off Oth Maj Total

1Q 16008 31804-01 **Kenai** C. Felice 15.98 0 0 0 0 0 0
2Q 16006 10911-06 **Jack** A. Heupel 20.36 0 0 0 0 0 0
 16011 18274-03 **Cooper** D. Coglietta NT 0 0 0 0 0 0

Distance: 86 yds SCT: 37 secs **Level 5 Regular/Veteran** 12 inch Judge: JoLee Yeddo
 Place Armband CPE ID Call Name Handler Time TFlts Bar Off Oth Maj Total

12010 18198-03 **Jennie** S. Budd Absent
1Q 12009 12038-09 **Halle** B. Garstin 25.39 0 0 0 0 0 0

Distance: 86 yds SCT: 32 secs **Level C Regular/Veteran** 20 inch Judge: JoLee Yeddo
 Place Armband CPE ID Call Name Handler Time TFlts Bar Off Oth Maj Total

3Q 20021 10804-03 **Fergie** S. Cappiello 24.37 0 0 0 0 0 0
2Q 20017 05450-06 **Pandemo...** D. Piroha 22.51 0 0 0 0 0 0
4Q 20014 12713-03 **Andy** L. Garfinkel 24.42 0 0 0 0 0 0
1Q 20004 V 10804-02 **Bosworth** S. Cappiello 20.90 0 0 0 0 0 0

Q 20003 V 25468-03 **Spark** J. Franke 26.82 0 0 0 0 0 0

Distance: 86 yds SCT: 32 secs **Level C Regular/Veteran** 16 inch Judge: JoLee Yeddo
Place Armband CPE ID Call Name Handler Time TFlts Bar Off Oth Maj Total

2Q 16007 30105-01 **Jem** M. Samuels 23.15 0 0 0 0 0 0
1Q 16014 V 01417-06 **Gooroo** V. Damant 20.60 0 0 0 0 0 0

Distance: 86 yds SCT: 37 secs **Level C Regular/Veteran** 12 inch Judge: JoLee Yeddo
Place Armband CPE ID Call Name Handler Time TFlts Bar Off Oth Maj Total

1Q 12003 16325-04 **Disney** D. Sroczynski 25.87 0 0 0 0 0 0

Distance: 86 yds SCT: 37 secs **Level C Regular/Veteran** 8 inch Judge: JoLee Yeddo
Place Armband CPE ID Call Name Handler Time TFlts Bar Off Oth Maj Total

2 8004 20344-02 **Junior** N. Kowal 38.00 1 1 0 0 0 6
1Q 8002 26964-01 **Lilly** K. Wasko 28.35 0 0 0 0 0 0

Distance: 86 yds SCT: 42 secs **Level 5 Enthusiast** (12) 8 inch Judge: JoLee Yeddo
Place Armband CPE ID Call Name Handler Time TFlts Bar Off Oth Maj Total

12008 T 05432-03 **Susie** B. Ogonowski Absent
1 12002 T 20873-02 **Sophie** M. Carlin 54.58 12 0 1 0 0 17

Distance: 86 yds SCT: 42 secs **Level C Enthusiast** (16) 12 inch Judge: JoLee Yeddo
Place Armband CPE ID Call Name Handler Time TFlts Bar Off Oth Maj Total

1Q 16005 T 30612-02 **Hazel** S. Johnson 27.77 0 0 0 0 0 0

Distance: 86 yds SCT: 37 secs **Level 5 Specialist** (24) 16 inch Judge: JoLee Yeddo
Place Armband CPE ID Call Name Handler Time TFlts Bar Off Oth Maj Total

1Q 24002 S 05450-04 **Mayhem** D. Piroha 22.25 0 0 0 0 0 0

Distance: 86 yds SCT: 42 secs **Level 5 Specialist** (20) 12 inch Judge: JoLee Yeddo
Place Armband CPE ID Call Name Handler Time TFlts Bar Off Oth Maj Total

1Q 20006 S 10917-02 **Abby** K. Mathieson 30.26 0 0 0 0 0 0

Skyline Agility Club (Club #44)

Sunday, November 20, 2022

Colors

Distance: 70 yds SCT: 42 secs **Level 1 Regular/Veteran** 12 inch Judge: JoLee Yeddo
 Place Armband CPE ID Call Name Handler Time TFlts Bar Off Oth Maj Total

1Q 12006 32994-01 **Ipsos Facto** M. Martin 14.68 0 0 0 0 0 0

Distance: 70 yds SCT: 42 secs **Level 1 Regular/Veteran** 8 inch Judge: JoLee Yeddo
 Place Armband CPE ID Call Name Handler Time TFlts Bar Off Oth Maj Total

1Q 8001 12038-11 **Lily** B. Garstin 27.09 0 0 0 0 0 0

Distance: 70 yds SCT: 32 secs **Level 2 Regular/Veteran** 16 inch Judge: JoLee Yeddo
 Place Armband CPE ID Call Name Handler Time TFlts Bar Off Oth Maj Total

1Q 16009 10807-02 **Luna** R. Lorig 19.39 0 0 0 0 0 0

Distance: 70 yds SCT: 42 secs **Level 1 Enthusiast** (20) 16 inch Judge: JoLee Yeddo
 Place Armband CPE ID Call Name Handler Time TFlts Bar Off Oth Maj Total

20018 T 22118-03 **Gator** K. Kalfas NT 0 0 0 0 0

Distance: 70 yds SCT: 47 secs **Level 1 Enthusiast** (16) 12 inch Judge: JoLee Yeddo
 Place Armband CPE ID Call Name Handler Time TFlts Bar Off Oth Maj Total

16018 T 10917-03 **Devyn** K. Mathieson NT 0 0 0 0 0

16017 T 14440-08 **MeiLi** D. Warren NT 0 0 0 0 0

Distance: 70 yds SCT: 47 secs **Level 1 Enthusiast** (12) 8 inch Judge: JoLee Yeddo
 Place Armband CPE ID Call Name Handler Time TFlts Bar Off Oth Maj Total

1 12001 T 20873-03 **Oliver** M. Carlin 30.08 0 0 3 0 1 30

Distance: 70 yds SCT: 37 secs **Level 2 Enthusiast** (20) 16 inch Judge: JoLee Yeddo
 Place Armband CPE ID Call Name Handler Time TFlts Bar Off Oth Maj Total

1Q 20012 T 01417-07 **Heathcliff** V. Damant 21.95 0 0 0 0 0 0

Distance: 70 yds SCT: 42 secs **Level 2 Enthusiast** (16) 12 inch Judge: JoLee Yeddo
 Place Armband CPE ID Call Name Handler Time TFlts Bar Off Oth Maj Total

2Q 16003 T 32416-01 **Lacey** E. Nadeau 24.98 0 0 0 0 0 0

1Q 16013 T 11138-04 Arya J. Yeddo 12.93 0 0 0 0 0 0

Skyline Agility Club (Club #44)

Sunday, November 20, 2022

Snooker

SCT: 45 secs **Level 3 Regular/Veteran** 16 inch Judge: JoLee Yeddo

Place	Armband	CPE ID	Call Name	Handler	Time	RC1	RC2	RC3	Cls	Score
2Q	16012	18274-04	Aurora	D. Coglietta	47.22	1+4	1+7	1+7	14	35
1Q	16008	31804-01	Kenai	C. Felice	44.75	1+4	1+7	1+7	20	41

SCT: 50 secs **Level 3 Regular/Veteran** 12 inch Judge: JoLee Yeddo

Place	Armband	CPE ID	Call Name	Handler	Time	RC1	RC2	RC3	Cls	Score
1Q	12009	12038-09	Halle	B. Garstin	43.96	1+4	1+6	1+7	27	47

SCT: 50 secs **Level 4 Regular/Veteran** 8 inch Judge: JoLee Yeddo

Place	Armband	CPE ID	Call Name	Handler	Time	RC1	RC2	RC3	Cls	Score
1Q	8005	12038-10	Dennis	B. Garstin	44.62	1+4	1+6	1+7	27	47

SCT: 45 secs **Level 5 Regular/Veteran** 20 inch Judge: JoLee Yeddo

Place	Armband	CPE ID	Call Name	Handler	Time	RC1	RC2	RC3	Cls	Score
1Q	20005	25468-04	Breeze	J. Franke	41.51	1+4	1+5	1+7	27	46

SCT: 45 secs **Level 5 Regular/Veteran** 16 inch Judge: JoLee Yeddo

Place	Armband	CPE ID	Call Name	Handler	Time	RC1	RC2	RC3	Cls	Score
1Q	16007	30105-01	Jem	M. Samuels	34.62	1+4	1+6	1+7	27	47
2Q	16006	10911-06	Jack	A. Heupel	39.79	1+4	1+6	1+7	20	40
3Q	16001	06411-04	Jedi	J. Hamilton	51.70	1+4	1+6	1+7	20	40
4	16011	18274-03	Cooper	D. Coglietta	19.71	1+4	1+6	1+7	0	20
	16015 V	12633-08	Justice	S. Herr	NT				0	

SCT: 50 secs **Level 5 Regular/Veteran** 12 inch Judge: JoLee Yeddo

Place	Armband	CPE ID	Call Name	Handler	Time	RC1	RC2	RC3	Cls	Score
1Q	12010	18198-03	Jennie	S. Budd	53.93	1+4	1+6	1+7	14	34

SCT: 45 secs **Level C Regular/Veteran** 20 inch Judge: JoLee Yeddo

Place	Armband	CPE ID	Call Name	Handler	Time	RC1	RC2	RC3	Cls	Score
	20021	10804-03	Fergie	S. Cappiello	54.77	1+7	1+7	1+6	2	25
4Q	20017	05450-06	Pandemo...	D. Piroha	45.00	1+4	1+6	1+7	20	40
1Q	20014	12713-03	Andy	L. Garfinkel	43.27	1+7	1+6	1+7	27	50

2Q	20004 V	10804-02	Bosworth	S. Cappiello	48.48	1+4	1+6	1+6	27	46
3Q	20003 V	25468-03	Spark	J. Franke	48.03	1+4	1+6	1+3	27	43

SCT: 45 secs **Level C Regular/Veteran** 16 inch Judge: JoLee Yeddo

Place	Armband	CPE ID	Call Name	Handler	Time	RC1	RC2	RC3	Cls	Score
1Q	16014 V	01417-06	GooRoo	V. Damant	51.59	1+7	1+6	1+7	20	43

SCT: 50 secs **Level C Regular/Veteran** 12 inch Judge: JoLee Yeddo

Place	Armband	CPE ID	Call Name	Handler	Time	RC1	RC2	RC3	Cls	Score
1Q	12003	16325-04	Disney	D. Sroczynski	47.49	1+4	1+6	1+3	27	43

SCT: 50 secs **Level C Regular/Veteran** 8 inch Judge: JoLee Yeddo

Place	Armband	CPE ID	Call Name	Handler	Time	RC1	RC2	RC3	Cls	Score
1Q	8004	20344-02	Junior	N. Kowal	58.53	1+4	1+6	1+7	20	40
	8002	26964-01	Lilly	K. Wasko	NT				0	

SCT: 45 secs **Level 3 Enthusiast** (20) 16 inch Judge: JoLee Yeddo

Place	Armband	CPE ID	Call Name	Handler	Time	RC1	RC2	RC3	Cls	Score
1Q	20012 T	01417-07	Heathcliff	V. Damant	60.05	1+7	1+6	1+3	20	39

SCT: 50 secs **Level 5 Enthusiast** (12) 8 inch Judge: JoLee Yeddo

Place	Armband	CPE ID	Call Name	Handler	Time	RC1	RC2	RC3	Cls	Score
	12008 T	05432-03	Susie	B. Ogonowski	Absent					
1	12002 T	20873-02	Sophie	M. Carlin	62.35	1+4	1+6	1+3	9	25

SCT: 50 secs **Level C Enthusiast** (16) 12 inch Judge: JoLee Yeddo

Place	Armband	CPE ID	Call Name	Handler	Time	RC1	RC2	RC3	Cls	Score
1Q	16005 T	30612-02	Hazel	S. Johnson	59.12	1+4	1+6	1+7	20	40

SCT: 45 secs **Level 5 Specialist** (24) 16 inch Judge: JoLee Yeddo

Place	Armband	CPE ID	Call Name	Handler	Time	RC1	RC2	RC3	Cls	Score
1Q	24002 S	05450-04	Mayhem	D. Piroha	49.51	1+4	1+6	1+7	20	40

Skyline Agility Club (Club #44)

Sunday, November 20, 2022

Snooker

SCT: 50 secs **Level 1 Regular/Veteran** 8 inch Judge: JoLee Yeddo

Place	Armband	CPE ID	Call Name	Handler	Time	RC1	RC2	RC3	Cls	Score
1Q	8001	12038-11	Lily	B. Garstin	41.39	1+2	1+5	1+4	27	41

SCT: 45 secs **Level 2 Regular/Veteran** 16 inch Judge: JoLee Yeddo

Place	Armband	CPE ID	Call Name	Handler	Time	RC1	RC2	RC3	Cls	Score
1	16009	10807-02	Luna	R. Lorig	32.84	1+2	1+5	1+5	0	15

SCT: 50 secs **Level 2 Regular/Veteran** 12 inch Judge: JoLee Yeddo

Place	Armband	CPE ID	Call Name	Handler	Time	RC1	RC2	RC3	Cls	Score
1Q	12006	32994-01	Ipsa Facto	M. Martin	38.39	1+2	1+7	1+3	27	42

SCT: 45 secs **Level 1 Enthusiast** (20) 16 inch Judge: JoLee Yeddo

Place	Armband	CPE ID	Call Name	Handler	Time	RC1	RC2	RC3	Cls	Score
	20018 T	22118-03	Gator	K. Kalfas	NT				0	

SCT: 50 secs **Level 1 Enthusiast** (16) 12 inch Judge: JoLee Yeddo

Place	Armband	CPE ID	Call Name	Handler	Time	RC1	RC2	RC3	Cls	Score
	16018 T	10917-03	Devyn	K. Mathieson	NT				0	
	16017 T	14440-08	MeiLi	D. Warren	NT				0	

Skyline Agility Club (Club #44)

Sunday, November 20, 2022

Standard

Distance: 148 yds SCT: 54 secs **Level 5 Regular/Veteran** 20 inch Judge: JoLee Yeddo
 Place Armband CPE ID Call Name Handler Time TFlts Bar Off Oth Maj Total

1Q	20005	25468-04	Breeze	J. Franke	42.64	0	0	0	0	0	0
2	20004 V	10804-02	Bosworth	S. Cappiello	45.49	0	0	0	0	1	15

Distance: 148 yds SCT: 54 secs **Level 5 Regular/Veteran** 16 inch Judge: JoLee Yeddo
 Place Armband CPE ID Call Name Handler Time TFlts Bar Off Oth Maj Total

4Q	16011	18274-03	Cooper	D. Coglietta	35.90	0	1	0	0	0	5
1Q	16008	31804-01	Kenai	C. Felice	37.09	0	0	0	0	0	0
2Q	16006	10911-06	Jack	A. Heupel	37.61	0	0	0	0	0	0
	16001	06411-04	Jedi	J. Hamilton	57.67	3	0	1	0	0	8
3Q	16015 V	12633-08	Justice	S. Herr	48.83	0	0	0	0	0	0

Distance: 148 yds SCT: 59 secs **Level 5 Regular/Veteran** 12 inch Judge: JoLee Yeddo
 Place Armband CPE ID Call Name Handler Time TFlts Bar Off Oth Maj Total

1Q	12010	18198-03	Jennie	S. Budd	55.45	0	0	0	0	0	0
2	12005	07934-05	Brodie	L. Henry	56.11	0	0	0	0	1	15

Distance: 148 yds SCT: 54 secs **Level C Regular/Veteran** 20 inch Judge: JoLee Yeddo
 Place Armband CPE ID Call Name Handler Time TFlts Bar Off Oth Maj Total

1Q	20021	10804-03	Fergie	S. Cappiello	40.41	0	0	0	0	0	0
4Q	20017	05450-06	Pandemo...	D. Piroha	53.42	0	0	0	0	0	0
3Q	20014	12713-03	Andy	L. Garfinkel	51.55	0	0	0	0	0	0
2Q	20003 V	25468-03	Spark	J. Franke	43.37	0	0	0	0	0	0

Distance: 148 yds SCT: 54 secs **Level C Regular/Veteran** 16 inch Judge: JoLee Yeddo
 Place Armband CPE ID Call Name Handler Time TFlts Bar Off Oth Maj Total

1Q	16007	30105-01	Jem	M. Samuels	32.31	0	0	0	0	0	0
2Q	16014 V	01417-06	GooRoo	V. Damant	41.25	0	0	0	0	0	0

Distance: 148 yds SCT: 59 secs **Level C Regular/Veteran** 12 inch Judge: JoLee Yeddo
 Place Armband CPE ID Call Name Handler Time TFlts Bar Off Oth Maj Total

1Q	12003	16325-04	Disney	D. Sroczynski	54.00	0	0	0	0	0	0
-----------	-------	----------	---------------	---------------	-------	---	---	---	---	---	---

Distance: 148 yds SCT: 59 secs **Level C Regular/Veteran** 8 inch Judge: JoLee Yeddo
 Place Armband CPE ID Call Name Handler Time TFlts Bar Off Oth Maj Total

2Q	8004	20344-02	Junior	N. Kowal	58.81	0	0	0	0	0	0
1Q	8002	26964-01	Lilly	K. Wasko	48.66	0	0	0	0	0	0

Distance: 148 yds SCT: 64 secs **Level 5 Enthusiast** (12) 8 inch Judge: JoLee Yeddo
 Place Armband CPE ID Call Name Handler Time TFlts Bar Off Oth Maj Total

	12002 T	20873-02	Sophie	M. Carlin	NT	0	0	0	0	0	0
--	---------	----------	---------------	-----------	----	---	---	---	---	---	---

Distance: 148 yds SCT: 64 secs **Level C Enthusiast** (16) 12 inch Judge: JoLee Yeddo
 Place Armband CPE ID Call Name Handler Time TFlts Bar Off Oth Maj Total

1	16005 T	30612-02	Hazel	S. Johnson	61.97	0	0	1	0	0	5
----------	---------	----------	--------------	------------	-------	---	---	---	---	---	---

Distance: 148 yds SCT: 59 secs **Level 5 Specialist** (24) 16 inch Judge: JoLee Yeddo
 Place Armband CPE ID Call Name Handler Time TFlts Bar Off Oth Maj Total

1Q	24002 S	05450-04	Mayhem	D. Piroha	53.07	0	0	0	0	0	0
-----------	---------	----------	---------------	-----------	-------	---	---	---	---	---	---

Skyline Agility Club (Club #44)

Sunday, November 20, 2022

Standard

Distance: 150 yds SCT: 65 secs **Level 2 Regular/Veteran** 16 inch Judge: JoLee Yeddo
 Place Armband CPE ID Call Name Handler Time TFlts Bar Off Oth Maj Total

1	16019	33472-01	KiKi Party	K. McNeil	48.37	0	0	4	0	2	50
2	16009	10807-02	Luna	R. Lorig	79.20	14	0	5	0	4	99

Distance: 150 yds SCT: 60 secs **Level 3 Regular/Veteran** 16 inch Judge: JoLee Yeddo
 Place Armband CPE ID Call Name Handler Time TFlts Bar Off Oth Maj Total

1	16012	18274-04	Aurora	D. Coglietta	57.26	0	0	3	0	5	90
----------	-------	----------	---------------	--------------	-------	---	---	---	---	---	----

Distance: 150 yds SCT: 70 secs **Level 2 Enthusiast** (20) 16 inch Judge: JoLee Yeddo
 Place Armband CPE ID Call Name Handler Time TFlts Bar Off Oth Maj Total

1Q	20012 T	01417-07	Heathcliff	V. Damant	71.05	1	0	1	0	0	6
-----------	---------	----------	-------------------	-----------	-------	---	---	---	---	---	---

Distance: 150 yds SCT: 80 secs **Level 2 Enthusiast** (16) 12 inch Judge: JoLee Yeddo
 Place Armband CPE ID Call Name Handler Time TFlts Bar Off Oth Maj Total

	16003 T	32416-01	Lacey	E. Nadeau	NT	0	0	0	0	0	
--	---------	----------	--------------	-----------	----	---	---	---	---	---	--

Distance: 122 yds SCT: 60 secs **Level 1 Enthusiast** (20) 16 inch Judge: JoLee Yeddo
 Place Armband CPE ID Call Name Handler Time TFlts Bar Off Oth Maj Total

	20018 T	22118-03	Gator	K. Kalfas	NT	0	0	0	0	0	
--	---------	----------	--------------	-----------	----	---	---	---	---	---	--

Distance: 122 yds SCT: 65 secs **Level 1 Enthusiast** (16) 12 inch Judge: JoLee Yeddo
 Place Armband CPE ID Call Name Handler Time TFlts Bar Off Oth Maj Total

	16018 T	10917-03	Devyn	K. Mathieson	NT	0	0	0	0	0	
	16017 T	14440-08	MeiLi	D. Warren	NT	0	0	0	0	0	

HighInTrial Report
CPE Trial 11/19/2022

HighInTrial Report

Place	Callname	Handler	ProgLev	Height	Points	Percentage
Regular						
1	Junior	Norbert Kowal	Reg LC	8	185	705.3693
2	Jem	Mark Samuels	Reg LC	16	175	1026.1125
3	Fergie	Susan Cappiello	Reg LC	20	170	853.0939
4	Breeze	Julie A Franke	Reg L5	20	165	885.4664
5	Andy	Lynne Garfinkel	Reg LC	20	155	648.5369
6	Lilly	Kathleen & Steven Wasko	Reg LC	8	150	864.6827
7	Jedi	Jill Hamilton	Reg L5	16	145	727.0363
8	Cooper	Diane Coglietta	Reg L5	16	130	684.7916
9	Aggi Jo	Betsi Hartman	Reg LC	20	110	581.2954
10	Pandemonium	Dorothy & Peter Piroha	Reg LC	20	110	527.4661
11	Disney	Dawn Sroczynski	Reg LC	12	90	430.6668
12	Jennie	Stacy Budd	Reg L5	12	90	407.6776
13	Ici Blue	Betsi Hartman	Reg LC	16	85	659.9560
14	Kenai	Christy Felice	Reg L5	16	85	527.7016
15	Jack	Anne Heupel	Reg L5	16	85	506.5219
16	Aurora	Diane Coglietta	Reg L3	16	75	438.5073
17	Mia	Marlene & Francis Buchel	Reg LC	8	65	350.7212
18	Halle	Brooke Garstin	Reg L5	12	65	321.3148
19	Lily	Brooke Garstin	Reg L1	8	60	367.1056
20	Ollie	Susan Rudy	Reg L2	12	60	342.2820
21	Gibbs	Caryl & Butch Jersey	Reg L5	20	60	290.3294
22	Apollo	Samira Khera	Reg L2	20	60	268.3155
23	Dennis	Brooke Garstin	Reg L4	8	45	217.5426
24	Ipso Facto	Misa Martin	Reg L2	12	40	416.3458
25	Dori Blue	Betsi Hartman	Reg LC	16	40	347.7570
26	KiKi Party	Klare McNeil	Reg L2	16	40	276.7289
27	Luna	Rebecca Lorig	Reg L2	16	40	239.1625
28	Angel	Samira Khera	Reg L2	20	40	152.0268
29	Dash	Jonathon Sample	Reg L1	20	35	460.9418
30	Brodie	Lois Henry	Reg L5	12	25	76.4025
31	Wallace	Barbara Tomeck	Reg L3	20	20	112.8624
32	Myles	Kim Krajcovic	Reg LC	12	20	89.6746
33	Ellie	Caryl & Butch Jersey	Reg L1	20	0.0000	
34	Wilbur	Troy Messenger	Reg L2	20	0.0000	

Summary Report (cont.)

Veteran

1	Spark	Julie A Franke	Vet LC	20	220	992.1131
2	GooRoo	Victoria Damant	Vet LC	16	110	560.6478
3	Bosworth	Susan Cappiello	Vet L5	20	105	502.6860
4	Justice	Sandy Herr	Vet L5	16	45	185.5503
5	Innes	Karen Mazarak	Vet L5	20	0.0000	
6	Dasher	Theresa Travis	Vet L5	20	0.0000	

Enthusiast

1	Heathcliff	Victoria Damant	Enth L2	20	100	500.0596
2	Hazel	Sarah Johnson	Enth LC	16	85	388.6768
3	Sophie	Madelyn Carlin	Enth L5	12	65	268.0114
4	Arya	JoLee & Jeremiah Yeddo	Enth L2	16	60	499.1833
5	Loki	Lori Gambill	Enth L2	24	40	228.7099
6	Little Man	Laura Bollenbach	Enth L5	16	40	208.0669
7	Jethro	Ryan Thompson	Enth L5	20	25	59.4295
8	Lacey	Ellen Nadeau	Enth L2	16	15	168.1345
9	Oliver	Madelyn Carlin	Enth L1	12	15	142.0872
10	Devyn	Kristen Mathieson	Enth L1	16	0.0000	
11	MeiLi	Darryl Warren	Enth L1	16	0.0000	
12	Gator	Kristine Kalfas	Enth L1	20	0.0000	
13	Tillie	Alisha Selzner	Enth L2	20	0.0000	
14	Susie	Bonnie Ogonowski	Enth L5	12	0.0000	

Specialist

1	Mayhem	Dorothy & Peter Piroha	Spec L5	24	110	548.9767
2	Abby	Kristen Mathieson	Spec L5	20	75	421.3308
3	Maisie	Richard Tucker	Spec L5	16	0.0000	

Jumpers 12

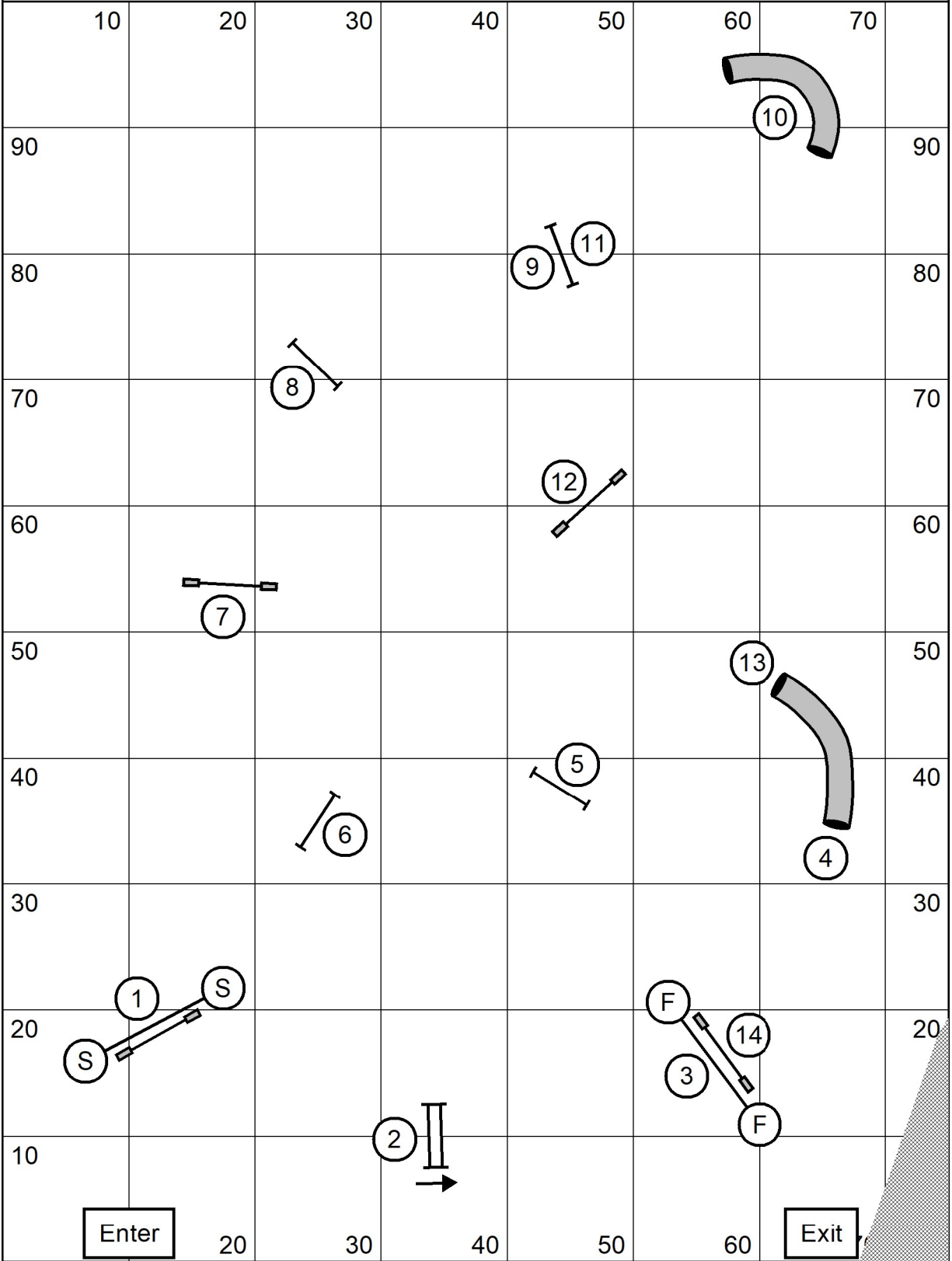

Jumpers Levels 1 & 2
 Judged by: JoLee Yeddo
 November 19, 2022
 Skyline Agility Club
 Middletown, NY

Jumpers 345C

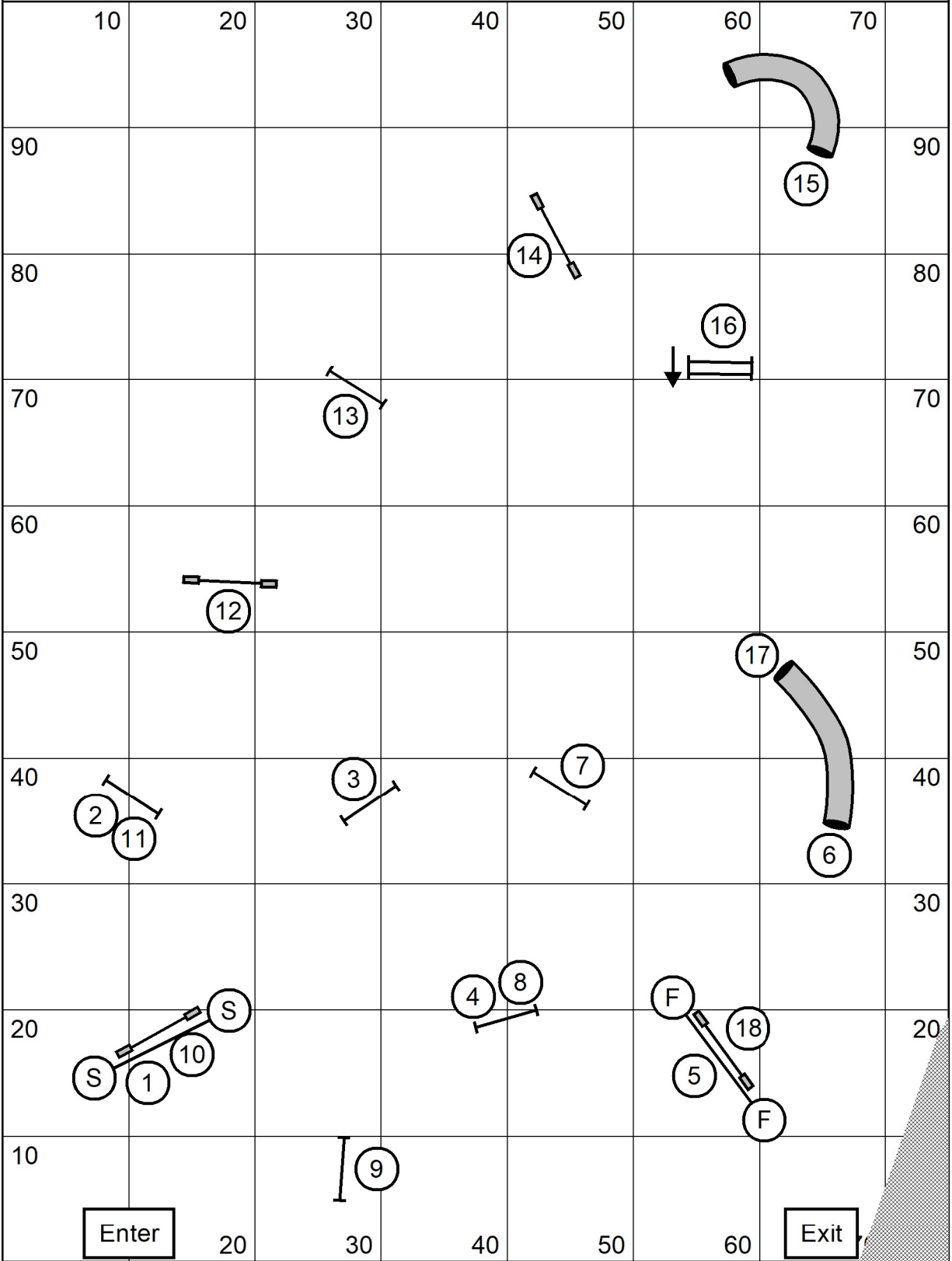

Jumpers Levels 3, 4, 5 & C
 Judged by: JoLee Yeddo
 November 19, 2022
 Skyline Agility Club
 Middletown, NY

Wildcard 12

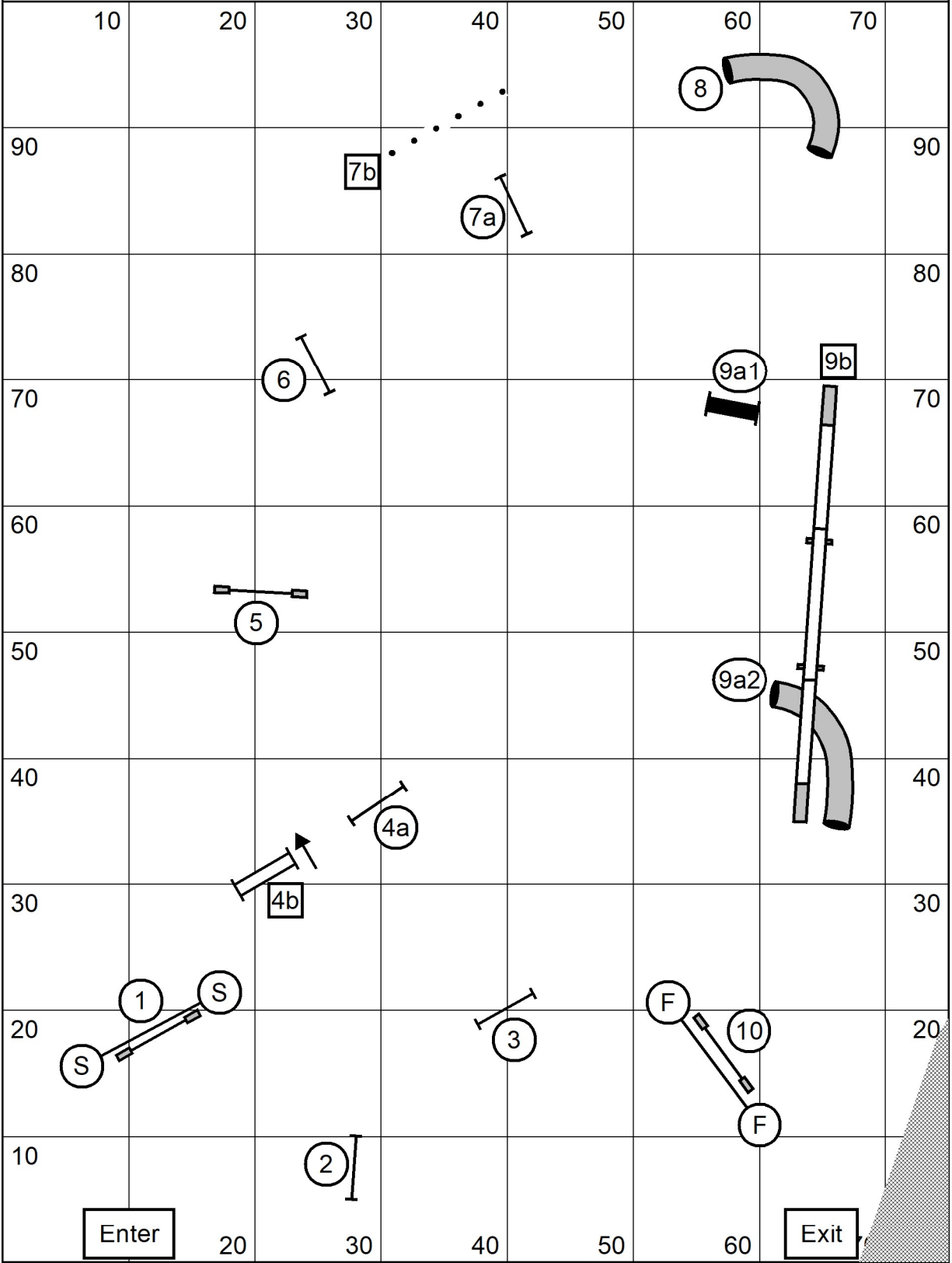

Wildcard Levels 1 & 2
 Judged by: JoLee Yeddo
 November 19, 2022
 Skyline Agility Club
 Middletown, NY

Jackpot 12

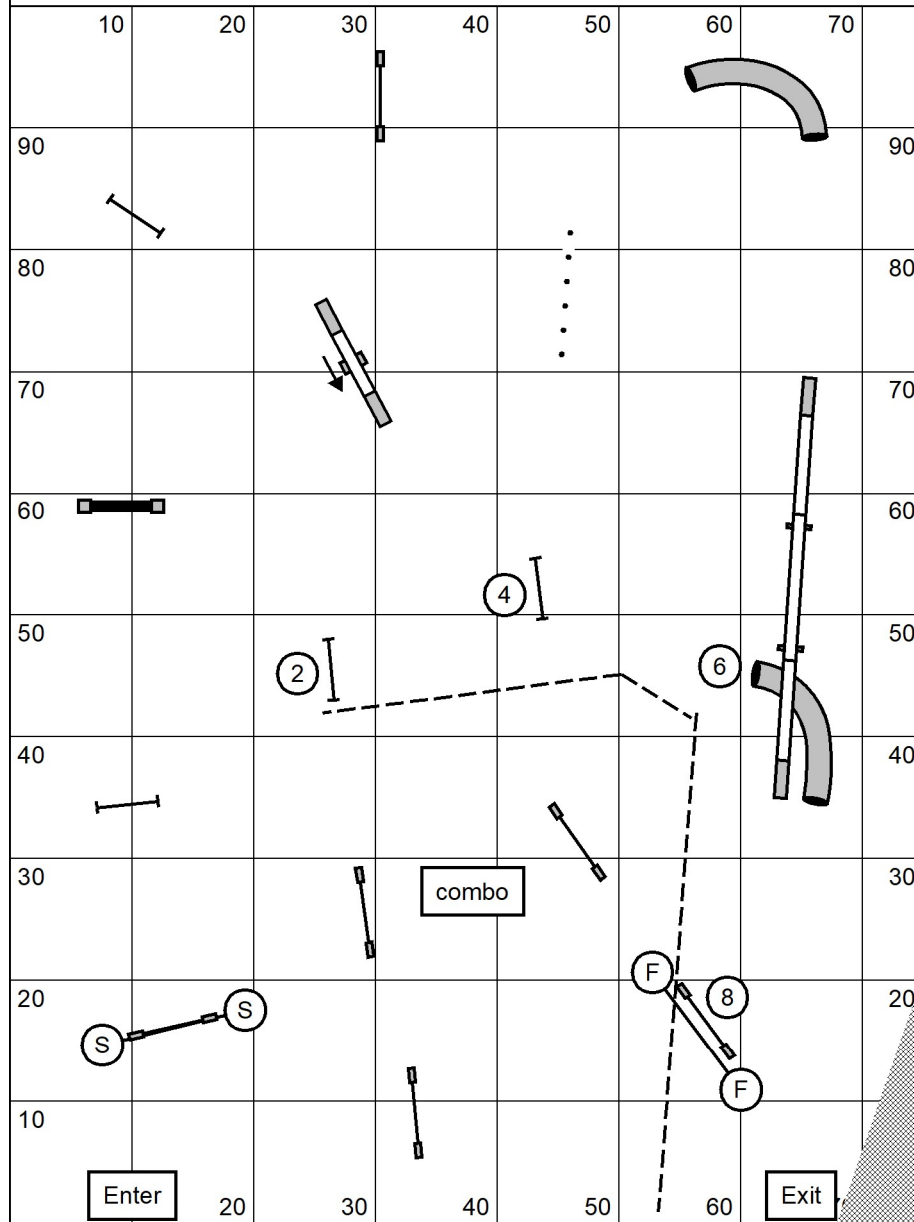

Traditional Jackpot

The start jump is bi-directional.

In the opening, collect points.
At the horn, attempt the gamble

Be careful not to negate your gamble during the opening
by doing two gamble obstacles forward or backward in order.

The final jump is live at the horn.

Obstacles may be done twice for points.
Back-to-back obstacles are fine if done safely.

5 points: dogwalk, teeter, combo in flow
3 points: tunnels, wall, weaves
1 point: jumps

4/8/12 inch dogs have 35 seconds, plus 20 after the horn.
16V/16/20/24 inch dogs have 30 seconds, plus 18 after the horn.

Jackpot Levels 1 & 2
Judged by: JoLee Yeddo
November 19, 2022
Skyline Agility Club
Middletown, NY

Jackpot 3

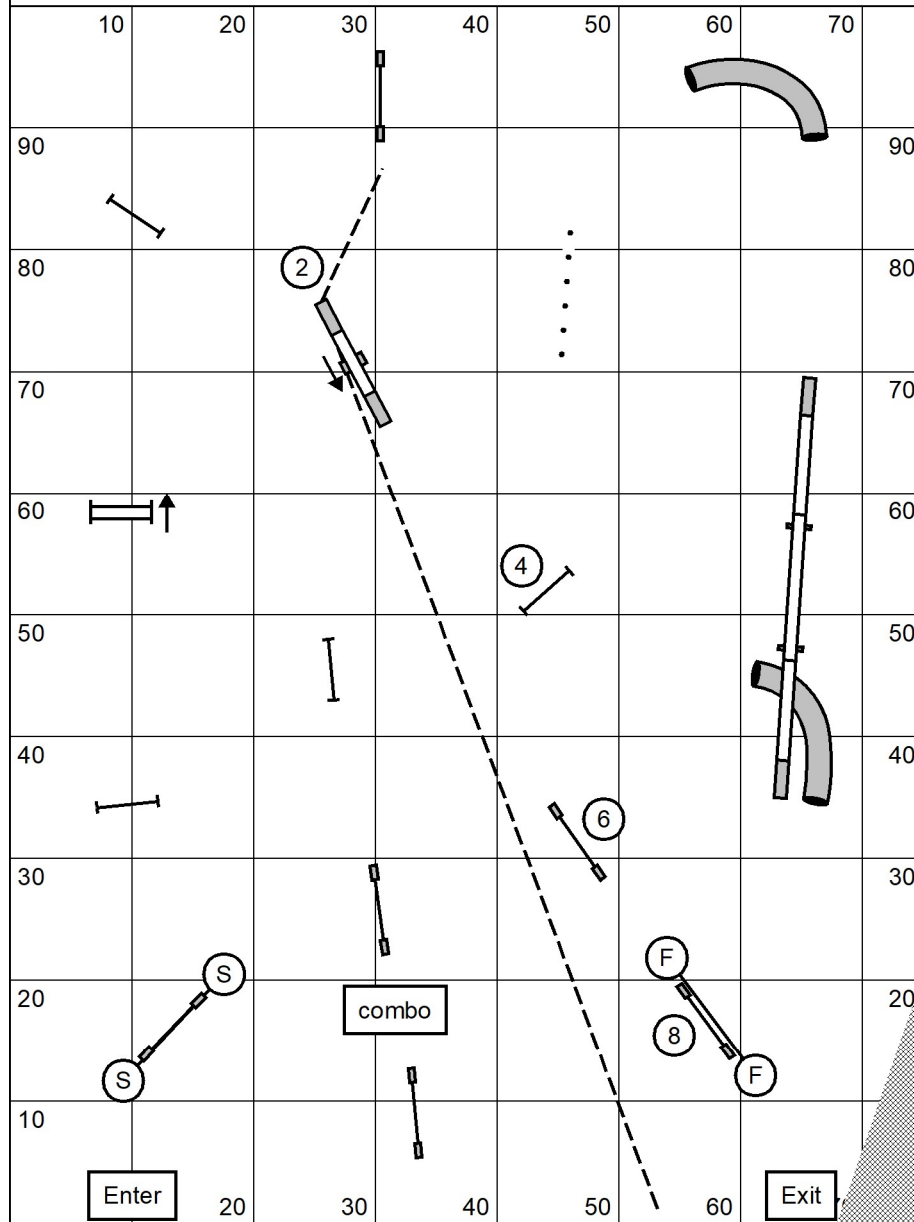

Traditional Jackpot

The start jump is bi-directional.

In the opening, collect points.
At the horn, attempt the gamble

Be careful not to negate your gamble during the opening
by doing two gamble obstacles forward or backward in order.

The final jump is live at the horn.

Obstacles may be done twice for points.
Back-to-back obstacles are fine if done safely.

5 points: dogwalk, teeter, combo in flow

3 points: tunnels, double, weaves

1 point: jumps

4/8/12 inch dogs have 35 seconds, plus 22 after the horn.

16V/16/20/24 inch dogs have 30 seconds, plus 20 after the horn.

Jackpot Level 3
Judged by: JoLee Yeddo
November 19, 2022
Skyline Agility Club
Middletown, NY

Jackpot 45C

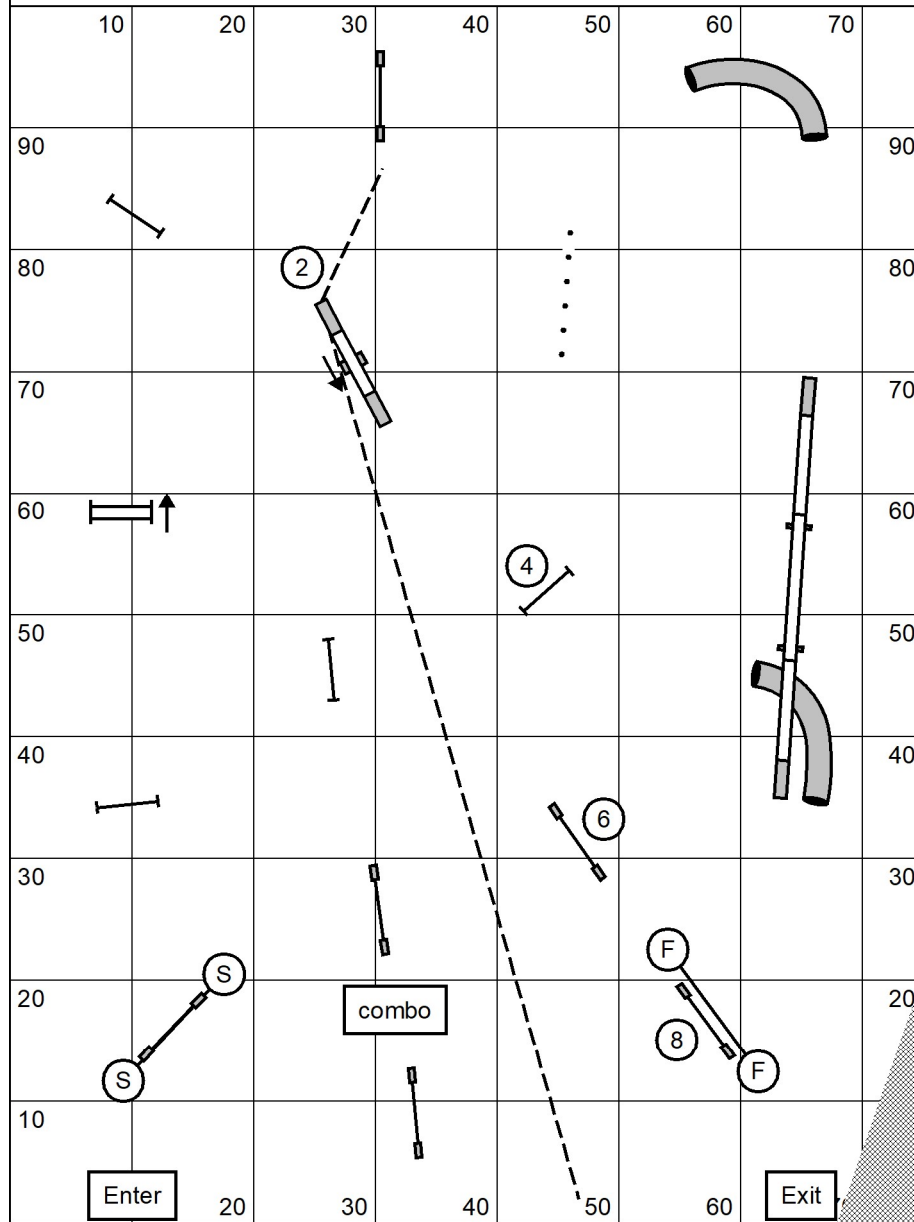

Traditional Jackpot

The start jump is bi-directional.

In the opening, collect points.
At the horn, attempt the gamble

Be careful not to negate your gamble during the opening
by doing two gamble obstacles forward or backward in order.

The final jump is live at the horn.

Obstacles may be done twice for points.
Back-to-back obstacles are fine if done safely.

5 points: dogwalk, teeter, combo in flow

3 points: tunnels, double, weaves

1 point: jumps

4/8/12 inch dogs have 35 seconds, plus 22 after the horn.

16V/16/20/24 inch dogs have 30 seconds, plus 20 after the horn.

Jackpot Levels 4, 5 & C
Judged by: JoLee Yeddo
November 19, 2022
Skyline Agility Club
Middletown, NY

Standard 45C

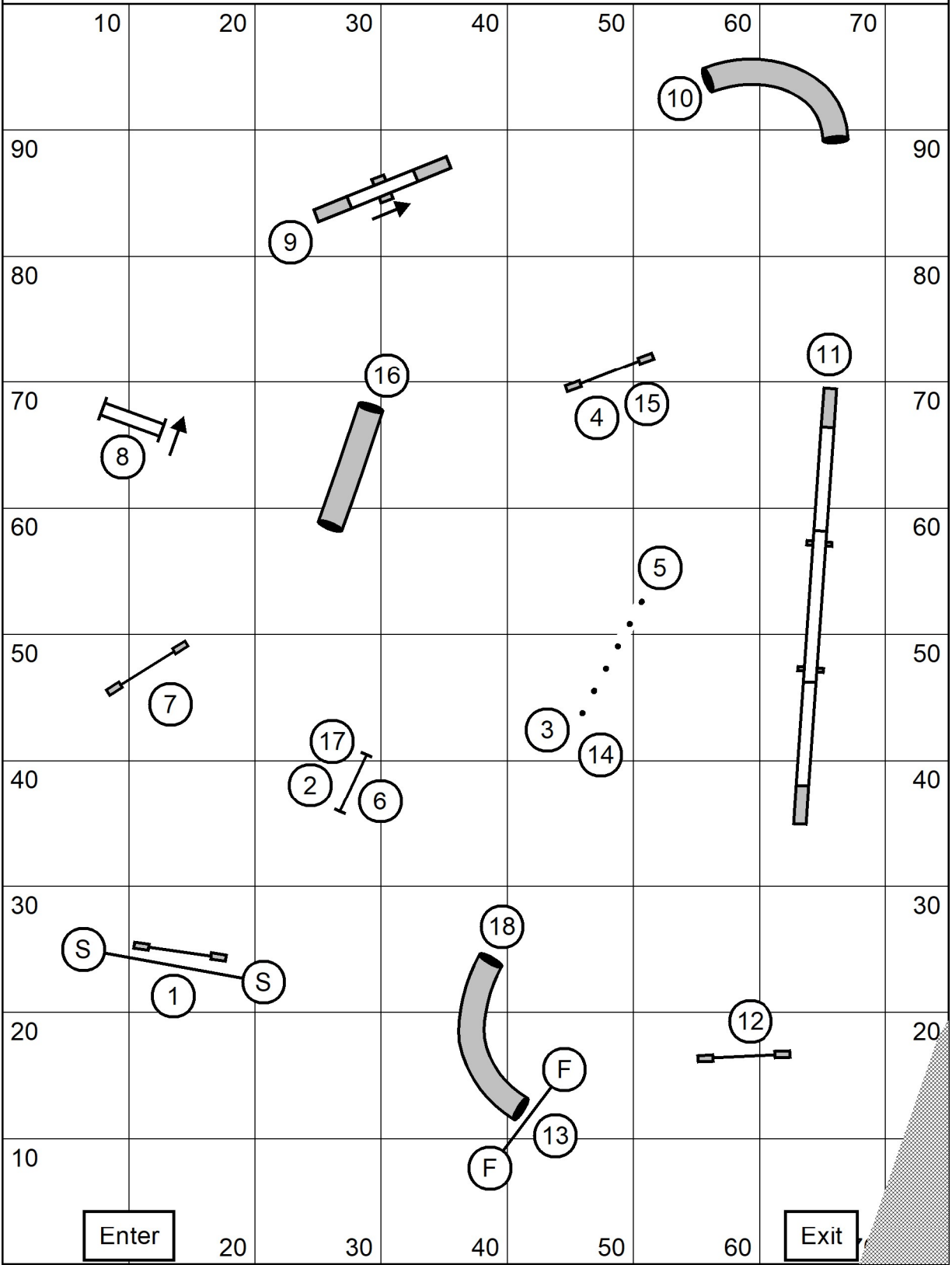

Standard Levels 4, 5 & C
 Judged by: JoLee Yeddo
 November 19, 2022
 Skyline Agility Club
 Middletown, NY

Standard 3

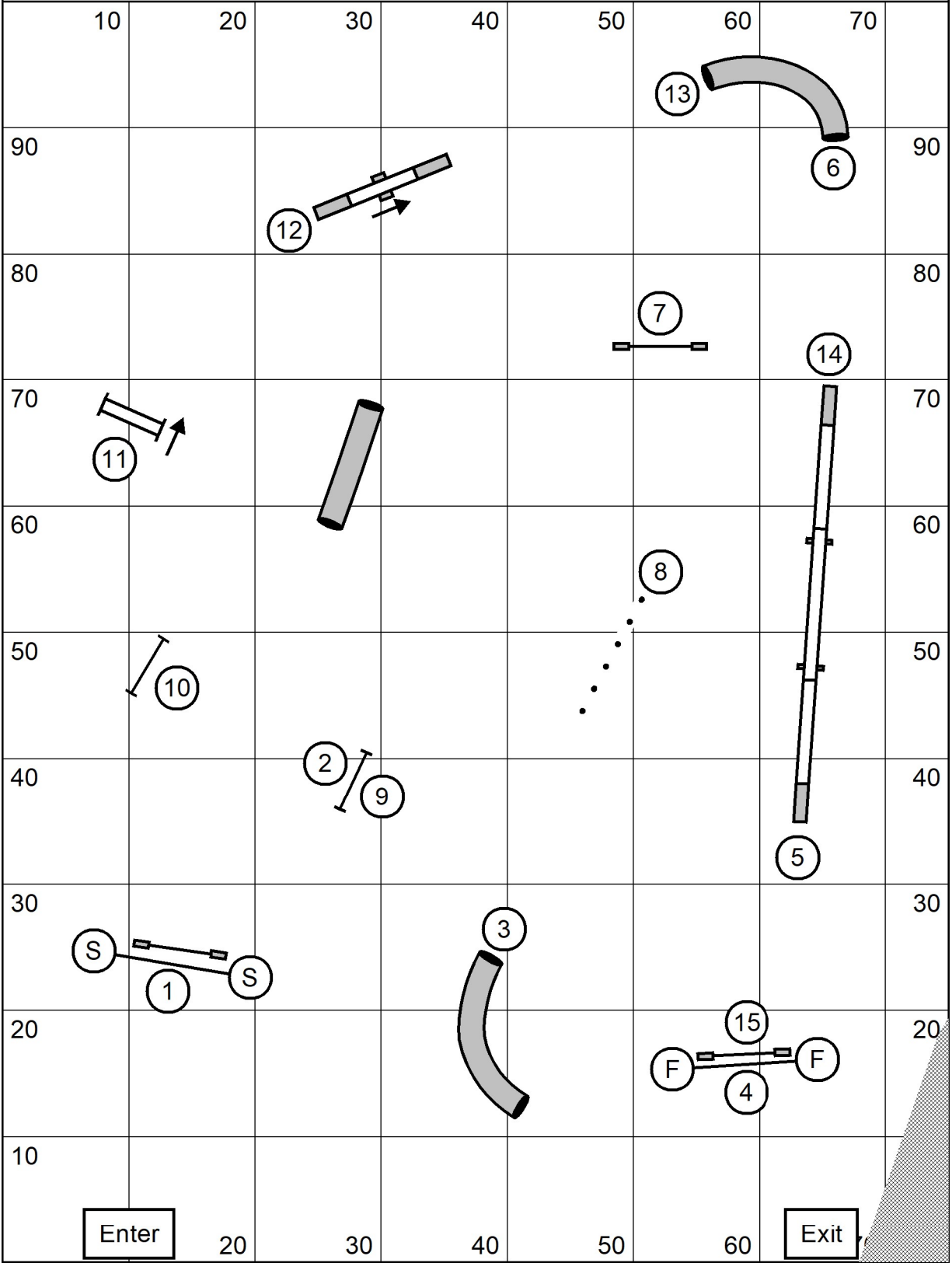

Standard Level 3
 Judged by: JoLee Yeddo
 November 19, 2022
 Skyline Agility Club
 Middletown, NY

Standard 2

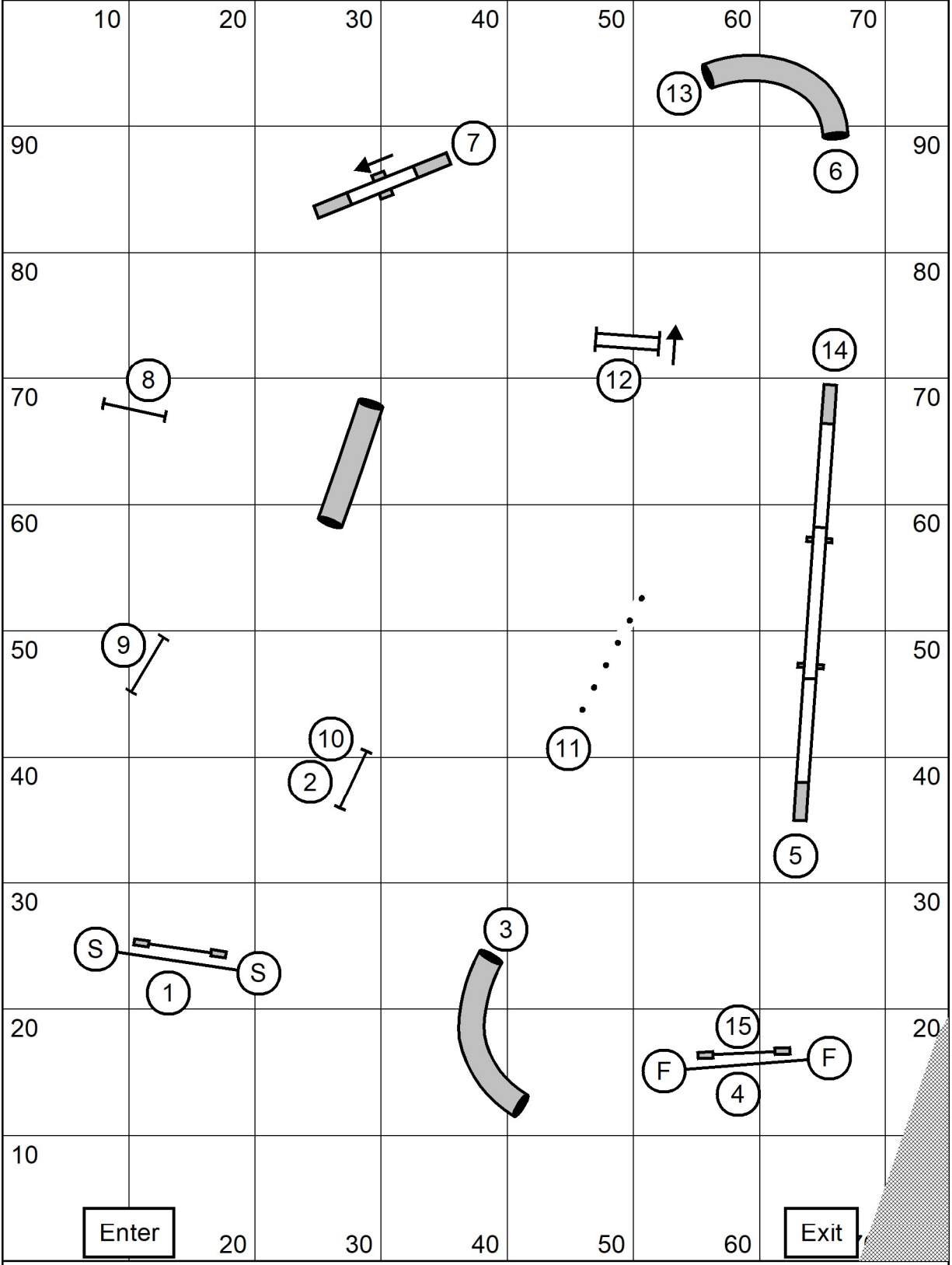

Standard Level 2
 Judged by: JoLee Yeddo
 November 19, 2022
 Skyline Agility Club
 Middletown, NY

Standard 1

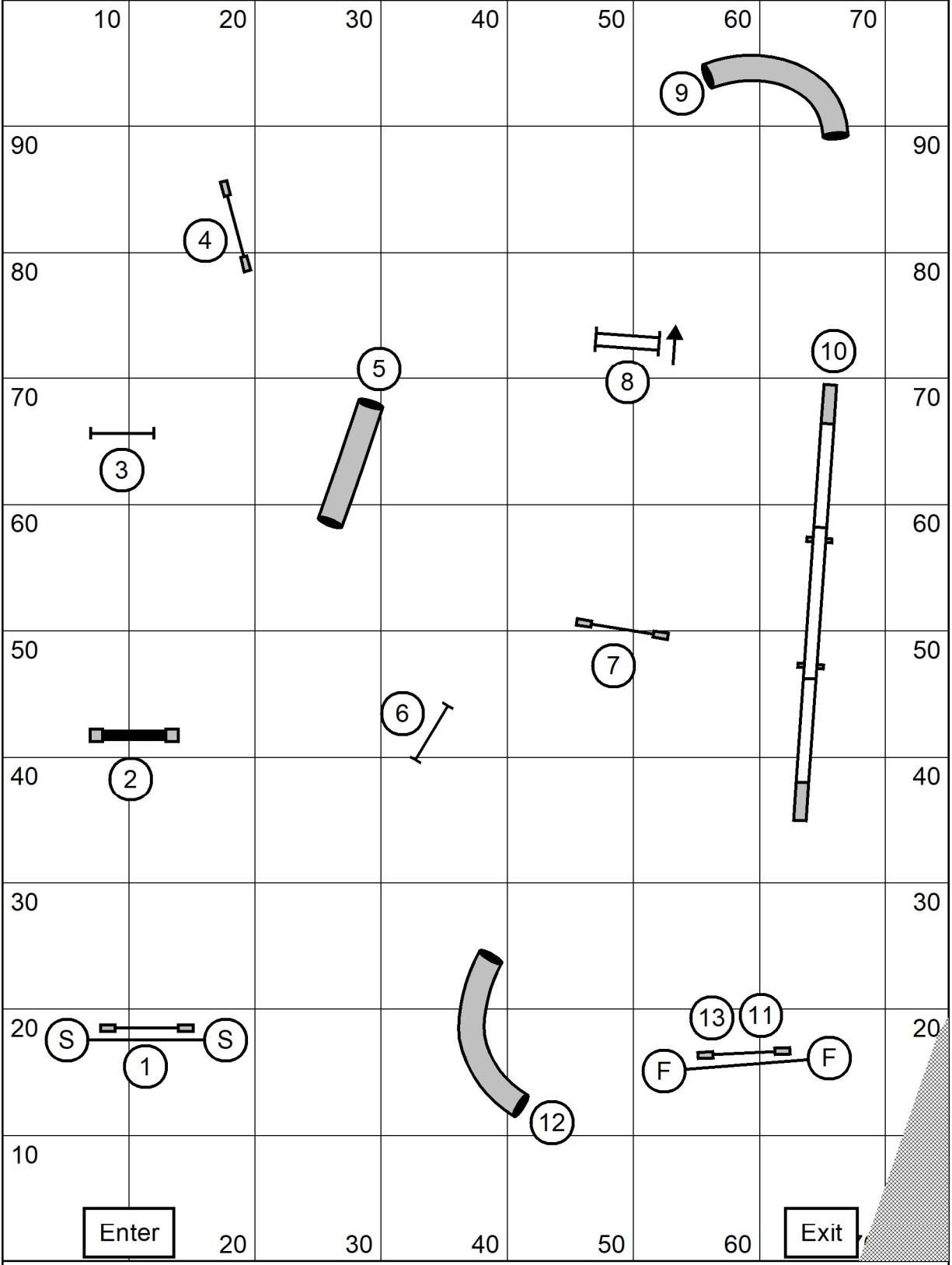

Standard Level 1
 Judged by: JoLee Yeddo
 November 19, 2022
 Skyline Agility Club
 Middletown, NY

CPE CHEAT SHEET

STANDARD CLASS

Level C: No Faults allowed – Score MUST be Zero Faults to Qualify. FAULTS	LEVEL 1	LEVEL 2	LEVEL 3 & S	LEVEL 4	LEVEL 5
Bar Down	1	1	1	1	1
Off Course	1	1	1	0	0
Other Flts.	1	1	1	1	1
Over Time	5	5	5	5	5
Max Faults	10	10	10	10	5

JUMPERS CLASS

Level C: No Faults allowed – Score MUST be Zero Faults to Qualify. FAULTS	LEVEL 1	LEVEL 2	LEVEL 3 & S	LEVEL 4	LEVEL 5
Bar Down	1	1	1	1	1
Off Course	1	1	1	0	0
Other Flts.	1	1	1	1	1
Over Time	5	5	5	5	5
Max Faults	10	10	10	10	5

WILDCARD CLASS

Level C: No Faults allowed – Score MUST be Zero Faults to Qualify. FAULTS	LEVEL 1	LEVEL 2	LEVEL 3 & S	LEVEL 4	LEVEL 5
Bar Down	1	1	1	1	1
Off Course	1	1	0	0	0
Other Faults	1	1	1	1	1
Over Time	5	5	5	5	5
Max Faults	10	10	10	10	5
Wildcards	2 X 1 PT 1 X 2 PT	2 X 1 PT 1 X 2 PT	1 X 1 PT 2 X 2 PT	1 X 1 PT 2 X 2 PT	1 X 1 PT 2 X 2 PT

COLORS CLASS

Level C: No Faults allowed – Score MUST be Zero Faults to Qualify. FAULTS	LEVEL 1	LEVEL 2	LEVEL 3 & S	LEVEL 4	LEVEL 5
Bar Down	NO LEVEL IS ALLOWED A BAR DOWN IN COLORS				
Off Course	1	1	0	0	0
Other Faults	1	1	1	1	1
Over Time	5	5	5	5	5
Max Faults	10	10	10	10	5

FULLHOUSE CLASS

REQUIRED FOR ALL: 3 x 1 point, 2 x 3 point, 1 x 5 point obstacles LEVEL	TOTAL POINTS TO Q	HEIGHTS & TIMES		
Level 1	19	JUMP HEIGHT	ACCUMULATION TIME	TOTAL GAME TIME
Level 2	21	4,8,12,S	35 sec	40 sec
Level 3 & S	23	16" Vet (at 12")	30 sec	35 sec
Level 4, 5 & C	25	16,20,24	30 sec	35 sec

SNOOKER CLASS

LEVEL	TOTAL POINTS TO Q	HEIGHTS & TIMES	
Level 1	26	JUMP HEIGHT	GAME TIME
Level 2	28	4,8,12,S	40-65 sec
Level 3 & S	30	16" Vet (at 12")	40-60 sec
Level 4, 5 & C	32	16, 20, 24	40-60 sec

JACKPOT CLASS

LEVEL	OPEN POINTS	GAMBLE POINTS	PTS TO Q	HEIGHTS & TIMES		
Level 1	12	20	32	JUMP HEIGHT	OPENING TIME	CLOSING TIME
Level 2	16	20	36	4, 8, 12, S	30-35 secs	Up to 20 sec
Level 3&S	20	20	40	16" vet (at 12")	25-30 secs	Up to 18 sec
Level 4, 5C	24	20	44	16, 20, 24	25-30 secs	Up to 18 sec

FullHouse 12345C

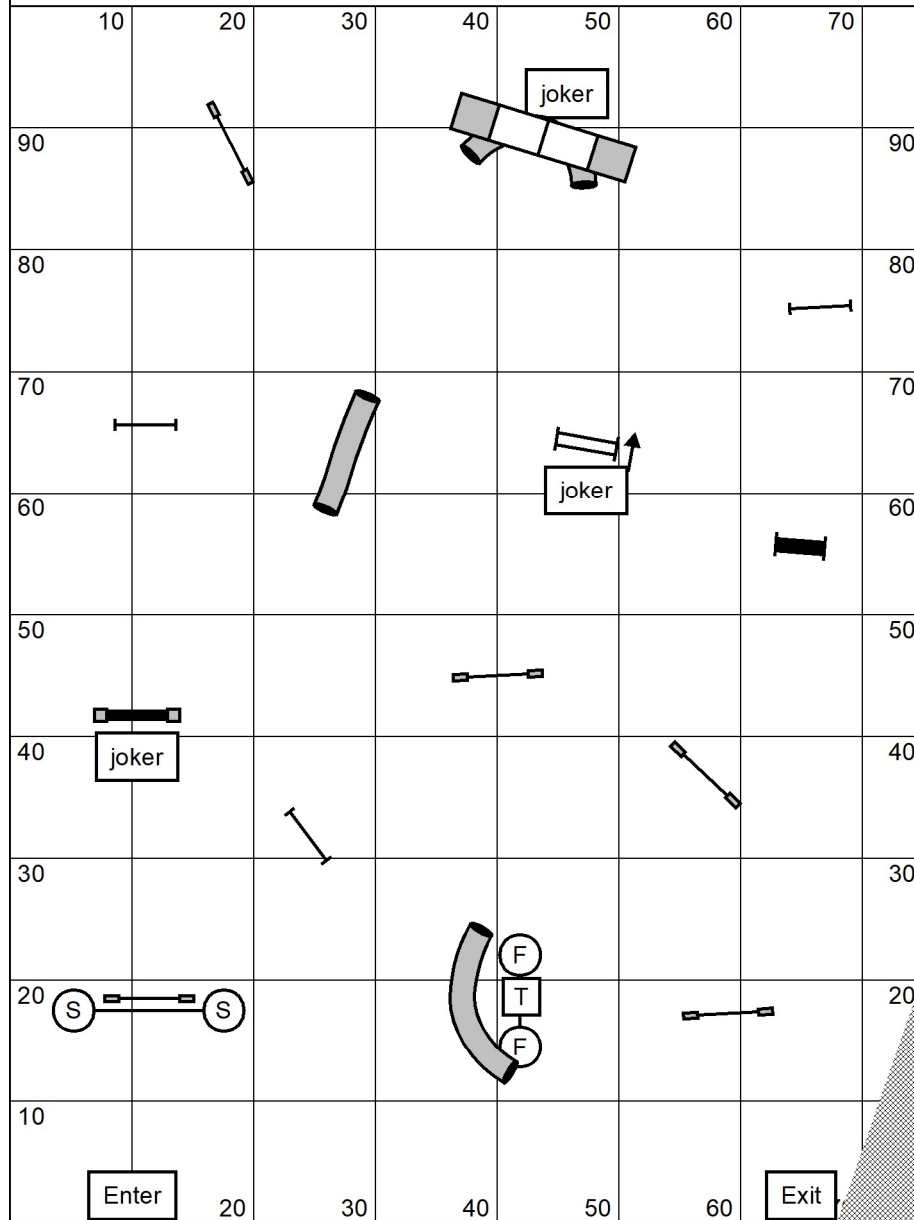

To qualify, earn the required points for your level, including at least:

- 1 - 5 point obstacle (AFrame, double, wall)
- 2 - 3 point obstacles (tunnels, panel)
- 3 - 1 point obstacles (jumps)

When the horn sounds, you have 5 seconds to get to the table before points will be deducted.

The start jump is bi-directional.

The table is live at all times.

Small Dogs: 35 seconds
Large Dogs: 30 seconds

FullHouse Levels 1, 2, 3, 4, 5 & C
Judged by: JoLee Yeddo
November 20, 2022
Skyline Agility Club
Middletown, NY

Jackpot 12345C

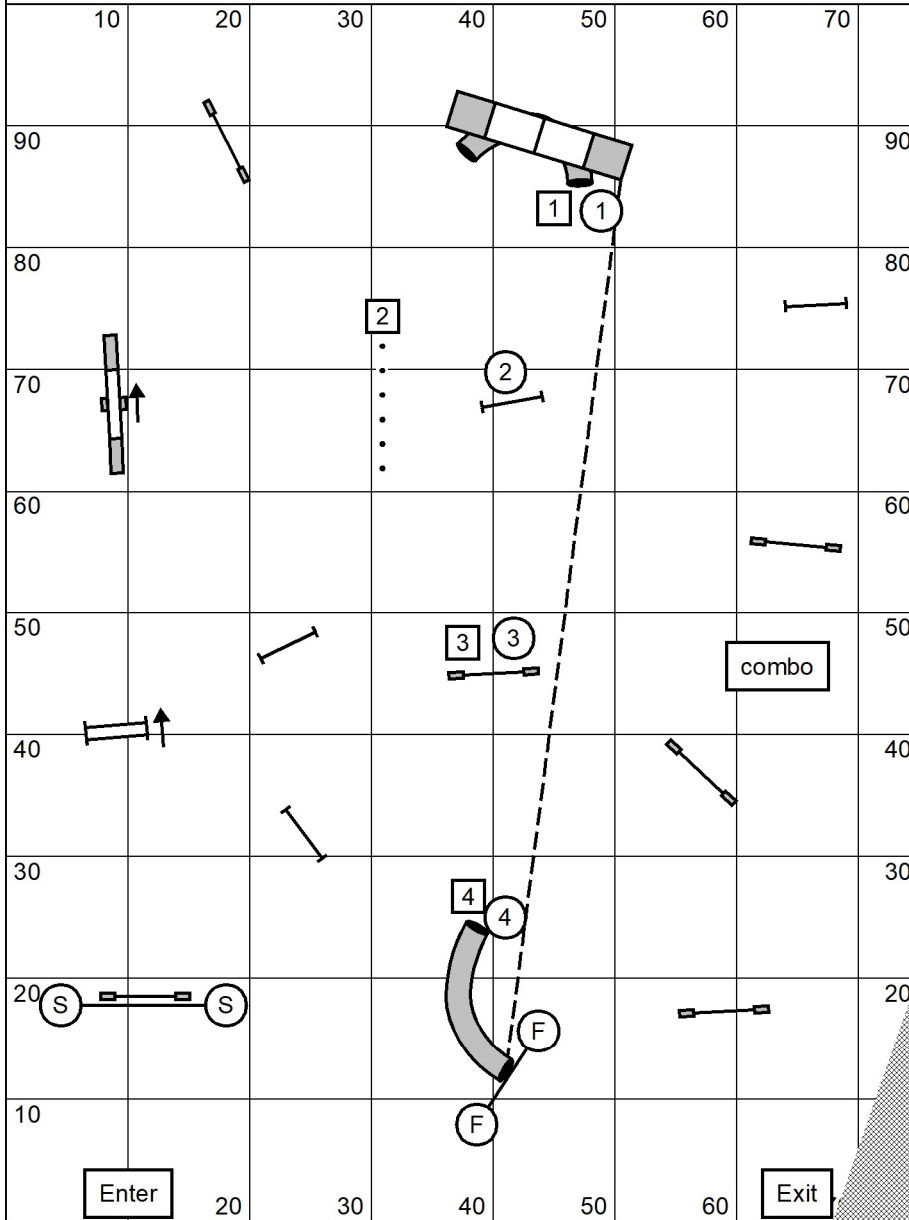

ALMOST Traditional Jackpot

In the opening, collect points.

At the horn, attempt a gamble.
Circles gamble is worth 20 points.
Squares gamble is worth 25 points.

The finish is live at the horn.

You will continue to earn points for obstacles taken after the horn on the way to the gamble.

Judging for the gamble will start when the dog takes #1 in the correct direction with the handler on the other side of the line.

Your gamble will **not** be negated in the opening by doing gamble obstacles forward or backward in order.

To qualify, you must successfully complete a gamble after the horn and earn the required points for your level without going over time.

Obstacles may be done twice for points outside of the gamble.
Back-to-back obstacles are fine if done safely.

5 points: A-Frame, teeter, combo in flow
3 points: tunnels, double, weaves
1 point: jumps

4/8/12 inch dogs have 35 seconds, plus 22 after the horn.
16V/16/20/24 inch dogs have 30 seconds, plus 20 after the horn.

Jackpot Levels 1, 2, 3, 4, 5 & C
Judged by: JoLee Yeddo
November 20, 2022
Skyline Agility Club
Middletown, NY

Colors 345C

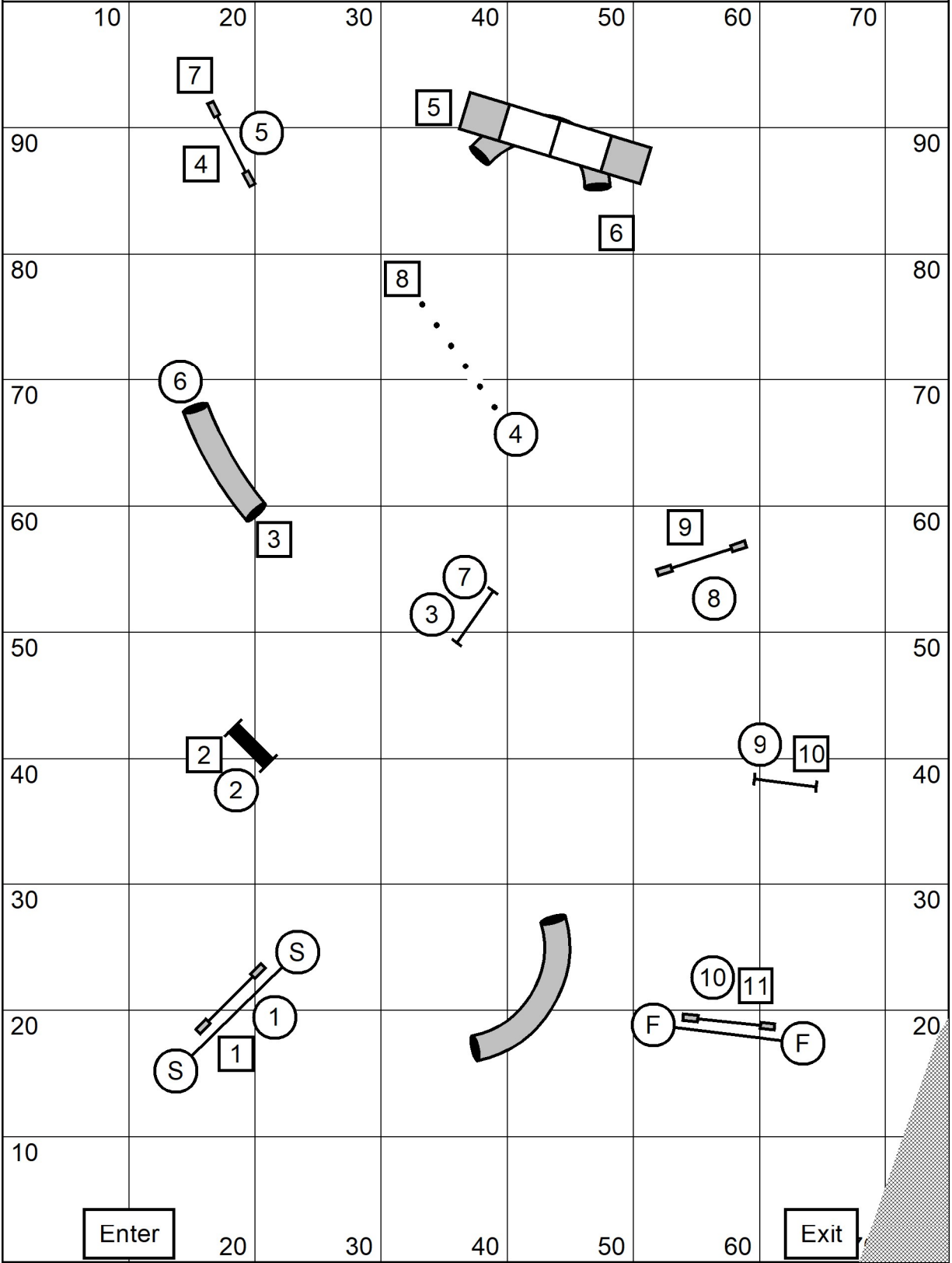

Colors Levels 3, 4, 5 & C
 Judged by: JoLee Yeddo
 November 20, 2022
 Skyline Agility Club
 Middletown, NY

Colors 12

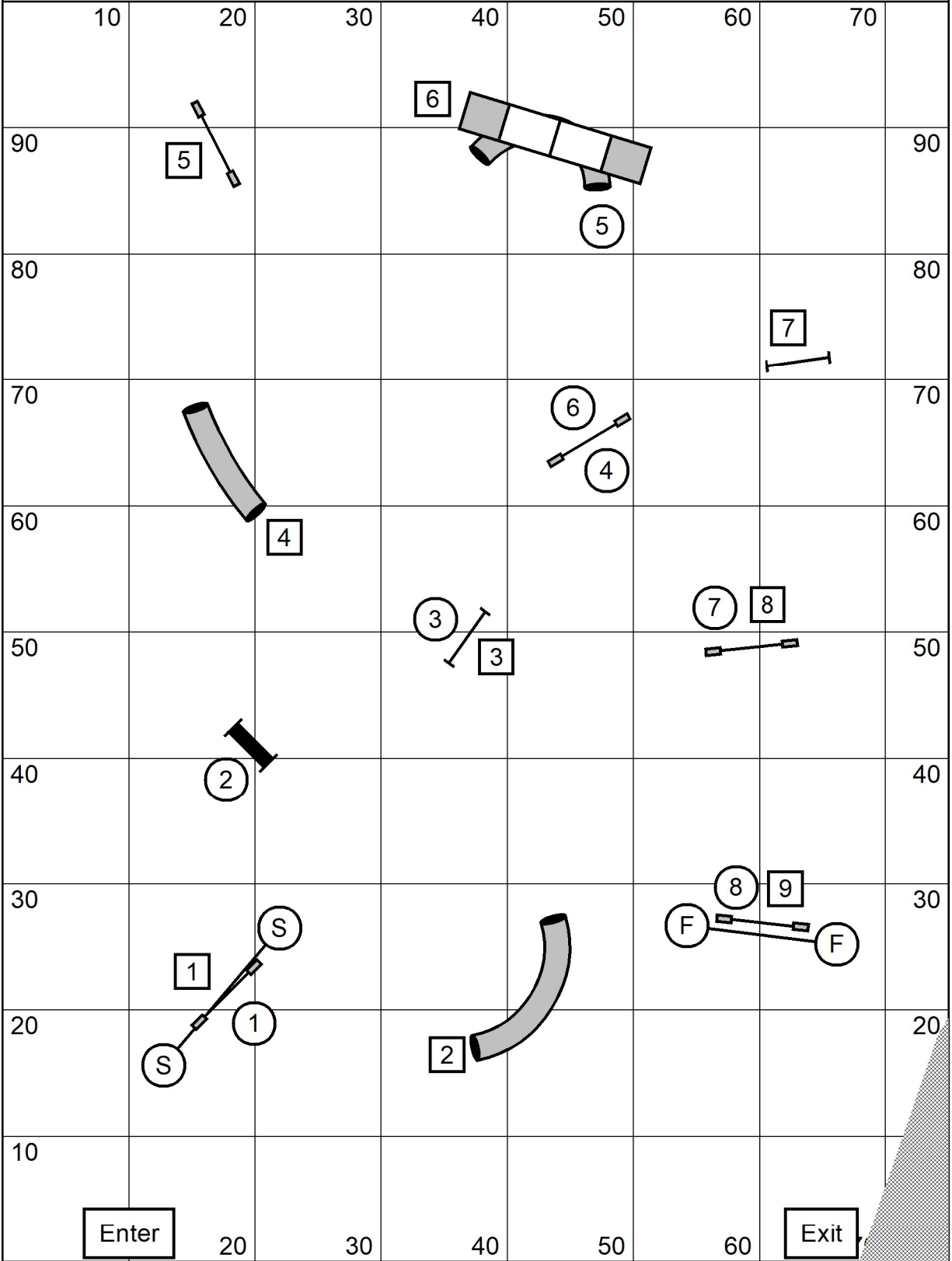

Colors Levels 1 & 2
 Judged by: JoLee Yeddo
 November 20, 2022
 Skyline Agility Club
 Middletown, NY

Snooker 345C

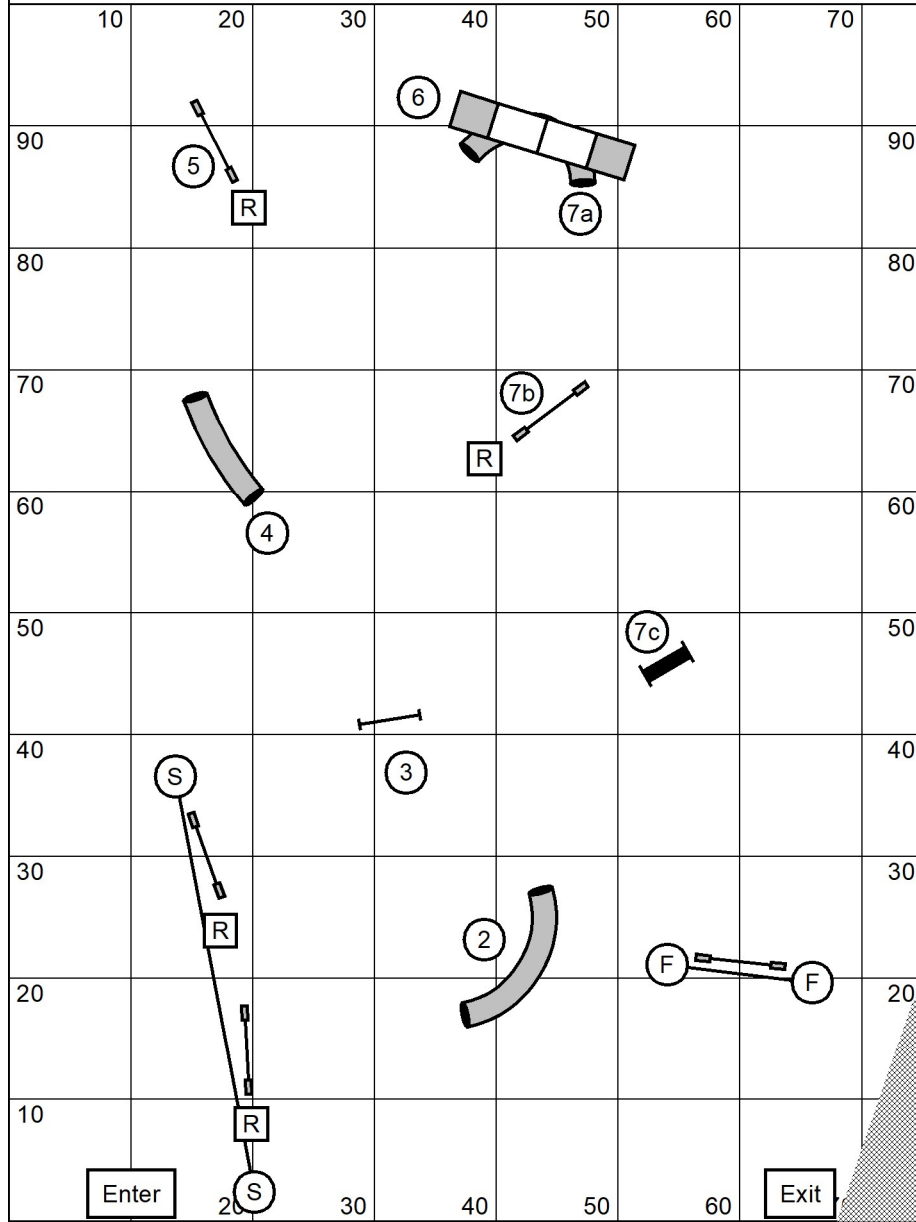

Opening: successful red followed by any color, 3 times
 colors are bi-directional
 combo in any order

The finish jump is live upon completion of the opening.

Closing: 2-7 in order, #2 is bi-directional,
 combo as numbered

Upon hearing the horn or "thank you," run to the finish.

4/8/12 dogs have 50 seconds

16V/16/20/24 dogs have 45 seconds

Snooker Levels 3, 4, 5 & C
 Judged by: JoLee Yeddo
 November 20, 2022
 Skyline Agility Club
 Middletown, NY

Snooker 12

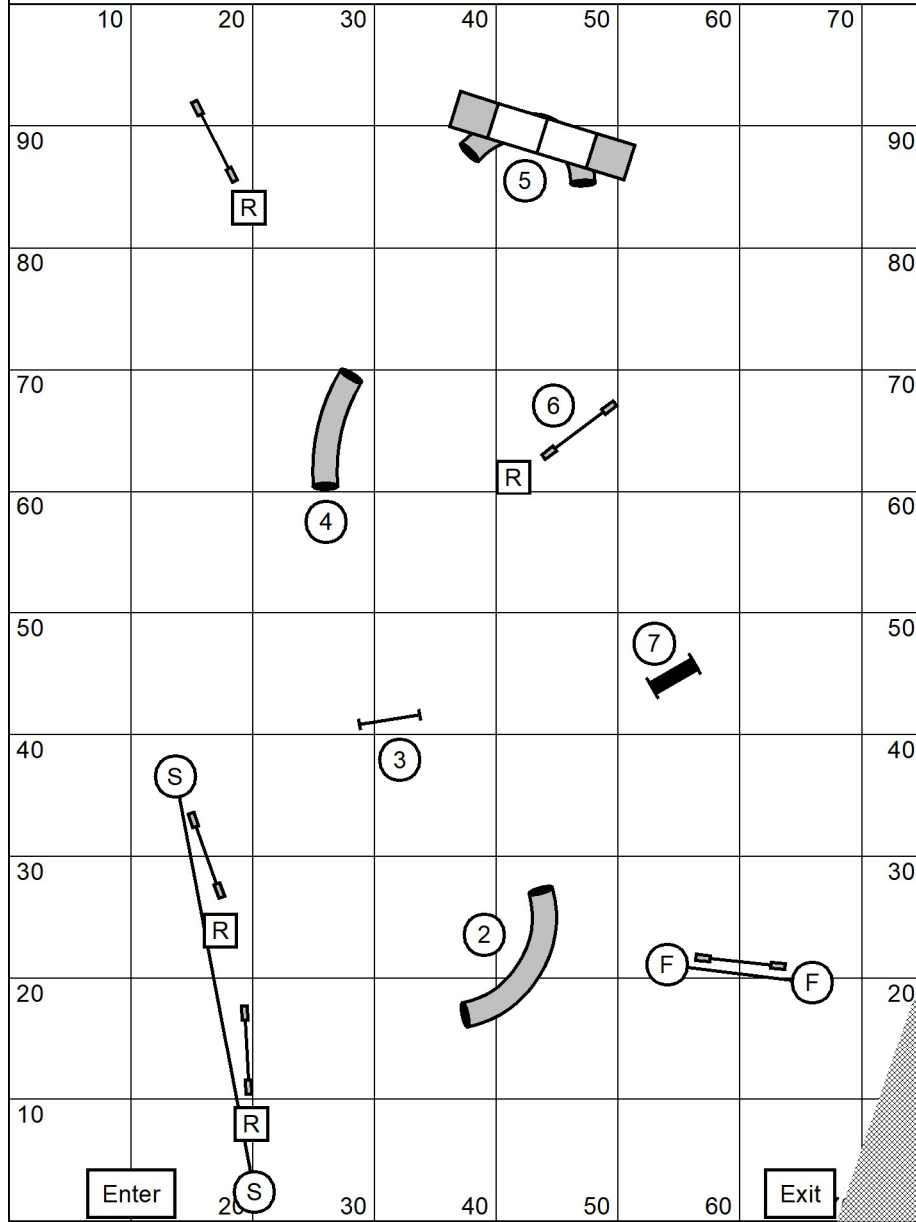

Opening: successful red followed by any color, 3 times
colors are bi-directional

The finish jump is live upon completion of the opening.

Closing: 2-7 in order, #2 & #5 are bi-directional

Upon hearing the horn or "thank you," run to the finish.

4/8/12 dogs have 50 seconds
16V/16/20/24 dogs have 45 seconds

Snooker Levels 1 & 2
Judged by: JoLee Yeddo
November 20, 2022
Skyline Agility Club
Middletown, NY

Standard 45C

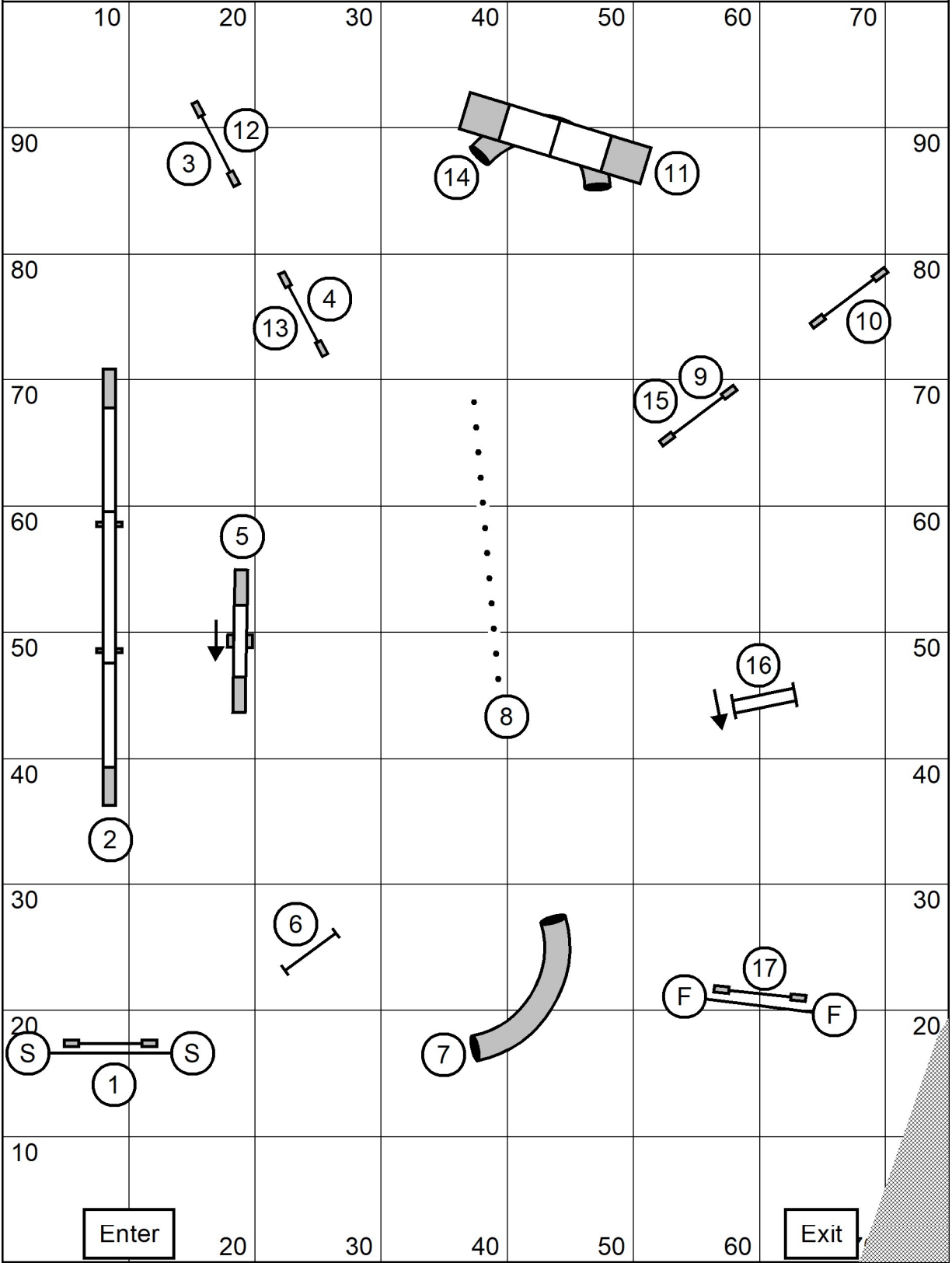

Standard Levels 4, 5 & C
 Judged by: JoLee Yeddo
 November 20, 2022
 Skyline Agility Club
 Middletown, NY

Standard 23

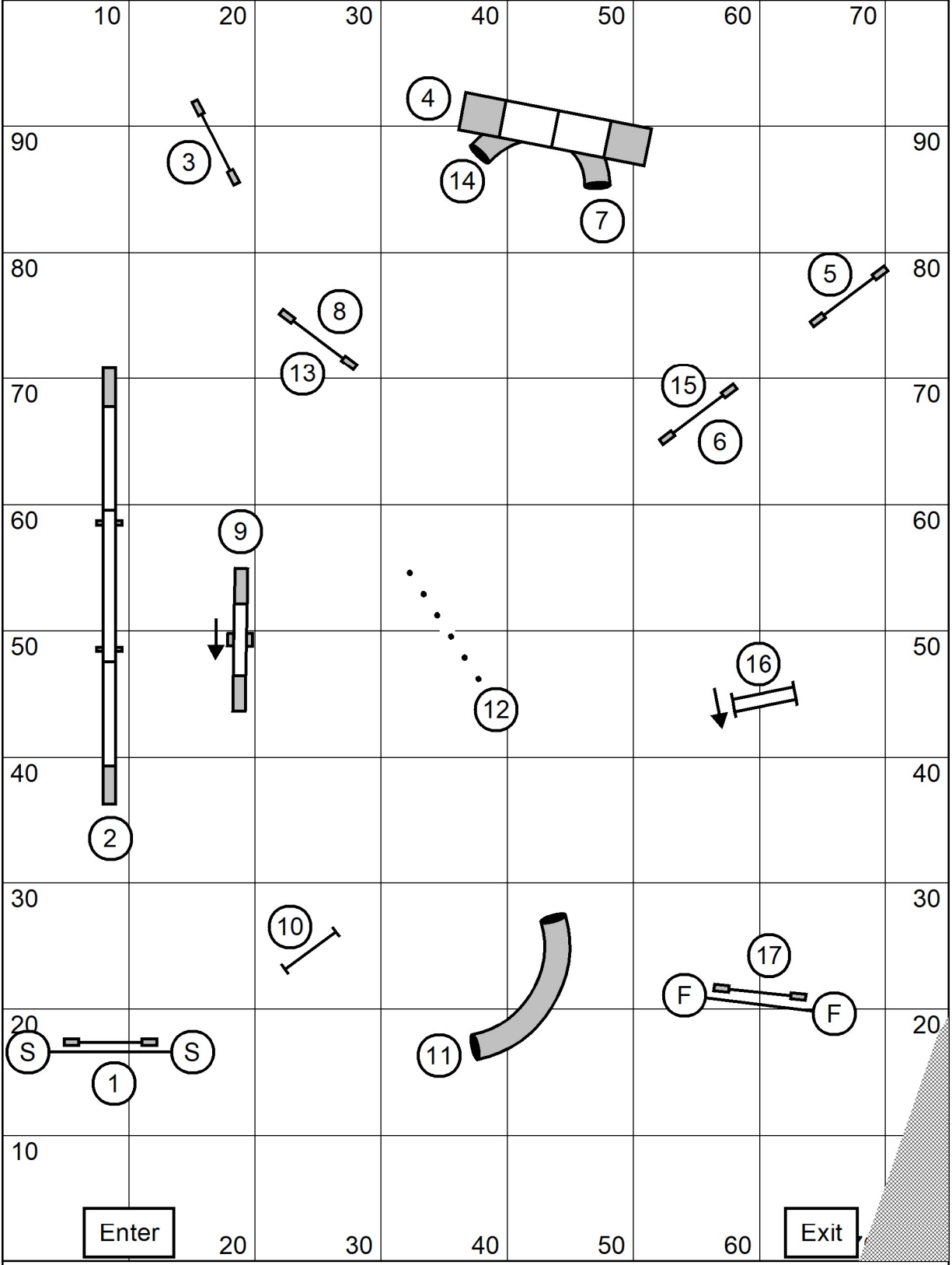

Standard Levels 2 & 3
 Judged by: JoLee Yeddo
 November 20, 2022
 Skyline Agility Club
 Middletown, NY

Standard 1

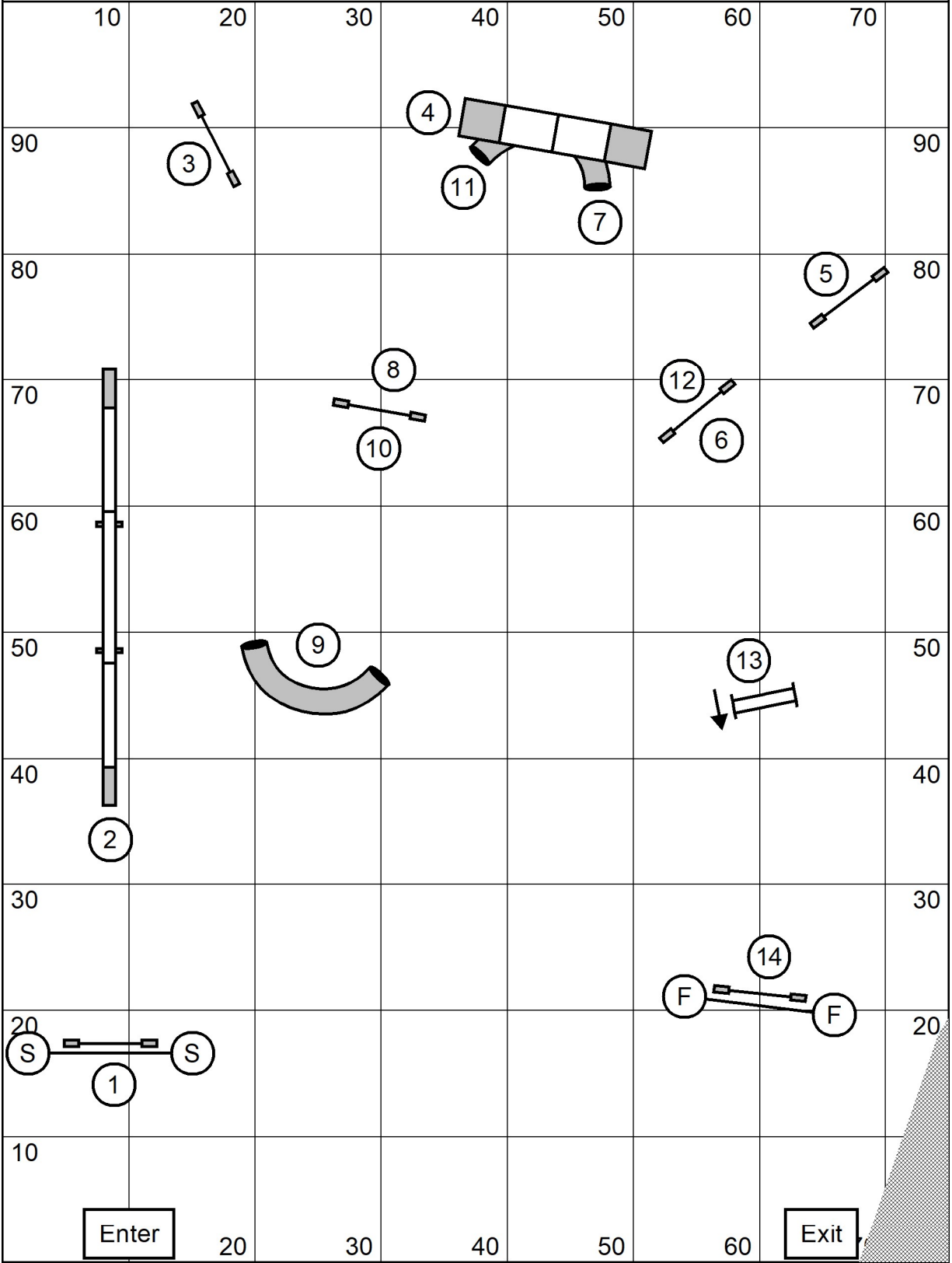

Standard Level 1
 Judged by: JoLee Yeddo
 November 20, 2022
 Skyline Agility Club
 Middletown, NY

CPE CHEAT SHEET

STANDARD CLASS

Level C: No Faults allowed – Score MUST be Zero Faults to Qualify. FAULTS	LEVEL 1	LEVEL 2	LEVEL 3 & S	LEVEL 4	LEVEL 5
Bar Down	1	1	1	1	1
Off Course	1	1	1	0	0
Other Flts.	1	1	1	1	1
Over Time	5	5	5	5	5
Max Faults	10	10	10	10	5

JUMPERS CLASS

Level C: No Faults allowed – Score MUST be Zero Faults to Qualify. FAULTS	LEVEL 1	LEVEL 2	LEVEL 3 & S	LEVEL 4	LEVEL 5
Bar Down	1	1	1	1	1
Off Course	1	1	1	0	0
Other Flts.	1	1	1	1	1
Over Time	5	5	5	5	5
Max Faults	10	10	10	10	5

WILDCARD CLASS

Level C: No Faults allowed – Score MUST be Zero Faults to Qualify. FAULTS	LEVEL 1	LEVEL 2	LEVEL 3 & S	LEVEL 4	LEVEL 5
Bar Down	1	1	1	1	1
Off Course	1	1	0	0	0
Other Faults	1	1	1	1	1
Over Time	5	5	5	5	5
Max Faults	10	10	10	10	5
Wildcards	2 X 1 PT 1 X 2 PT	2 X 1 PT 1 X 2 PT	1 X 1 PT 2 X 2 PT	1 X 1 PT 2 X 2 PT	1 X 1 PT 2 X 2 PT

COLORS CLASS

Level C: No Faults allowed – Score MUST be Zero Faults to Qualify. FAULTS	LEVEL 1	LEVEL 2	LEVEL 3 & S	LEVEL 4	LEVEL 5
Bar Down	NO LEVEL IS ALLOWED A BAR DOWN IN COLORS				
Off Course	1	1	0	0	0
Other Faults	1	1	1	1	1
Over Time	5	5	5	5	5
Max Faults	10	10	10	10	5

FULLHOUSE CLASS

REQUIRED FOR ALL: 3 x 1 point, 2 x 3 point, 1 x 5 point obstacles LEVEL	TOTAL POINTS TO Q	HEIGHTS & TIMES		
Level 1	19	JUMP HEIGHT	ACCUMULATION TIME	TOTAL GAME TIME
Level 2	21	4,8,12,S	35 sec	40 sec
Level 3 & S	23	16" Vet (at 12")	30 sec	35 sec
Level 4, 5 & C	25	16,20,24	30 sec	35 sec

SNOOKER CLASS

LEVEL	TOTAL POINTS TO Q	HEIGHTS & TIMES	
Level 1	26	JUMP HEIGHT	GAME TIME
Level 2	28	4,8,12,S	40-65 sec
Level 3 & S	30	16" Vet (at 12")	40-60 sec
Level 4, 5 & C	32	16, 20, 24	40-60 sec

JACKPOT CLASS

LEVEL	OPEN POINTS	GAMBLE POINTS	PTS TO Q	HEIGHTS & TIMES		
Level 1	12	20	32	JUMP HEIGHT	OPENING TIME	CLOSING TIME
Level 2	16	20	36	4, 8, 12, S	30-35 secs	Up to 20 sec
Level 3&S	20	20	40	16" vet (at 12")	25-30 secs	Up to 18 sec
Level 4, 5C	24	20	44	16, 20, 24	25-30 secs	Up to 18 sec